

# MOŽNOSTI NAVÍJANIA A UMIESTNENIE VODIACICH LIŠŤ PRE NAVÍJACIE BRÁNY - SÚKROMNÝ SEKTOR

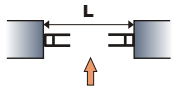

B

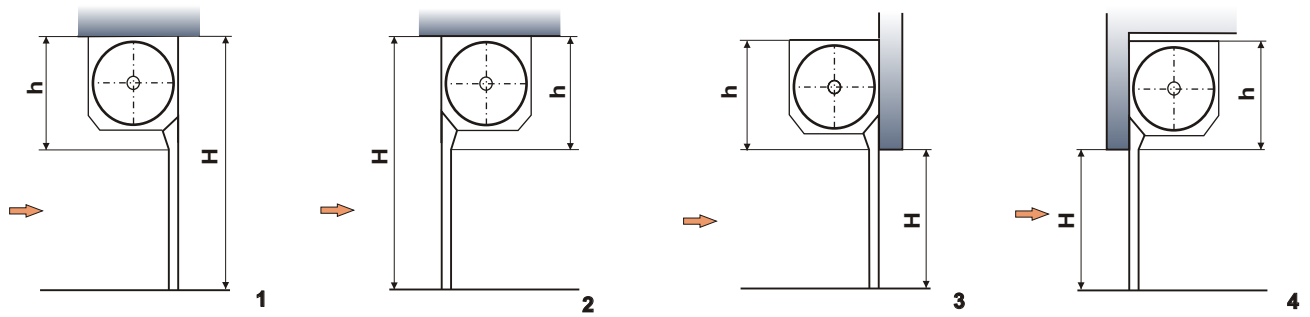
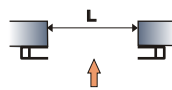

D

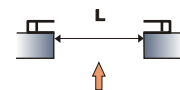

E

## Legenda:

L = svetlá šírka otvoru  
 H = svetlá výška otvoru  
 LP = priemer navinutia brány  
 h = preklad  
 f = hrúbka vod.lišty  
 s = šírka vod. lišty

**Max. celková plocha brány vrátane prekladu je 15 m<sup>2</sup>, váha 5,0 kg/m.**

šírka brány max.

L

4800

4800

4800

Al vodiace lišty

s

f

100 x 34

100 x 34

100 x 34

PROFIL VODIACEJ LIŠTY

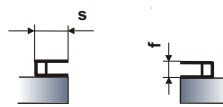

príklad umiestnenia vodiacich lišt - obr. E

výška otvoru

H

2000

2500

2700

preklad

h

300

350

400

priemer navinutia brány LP

250

300

350

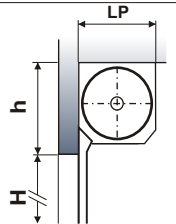

## MOTOR V HRIADELI

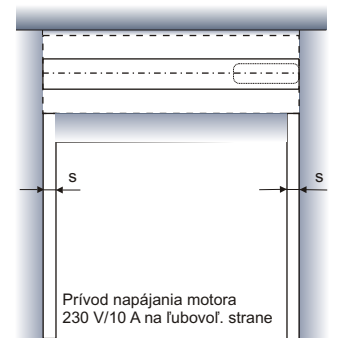

Prívod napájania motora  
 230 V/10 A na ľubovoľ. strane