

New

Portoni in legno

Wooden Doors
Holztore



Wood Line / Pegaso Line



BREDA[®]

SISTEMI INDUSTRIALI

PORTONI SEZIONALI EVOLUTI

Ogni portone sezionale Breda è: Each sectional door by Breda is: Jedes Breda Sektionaltor ist:

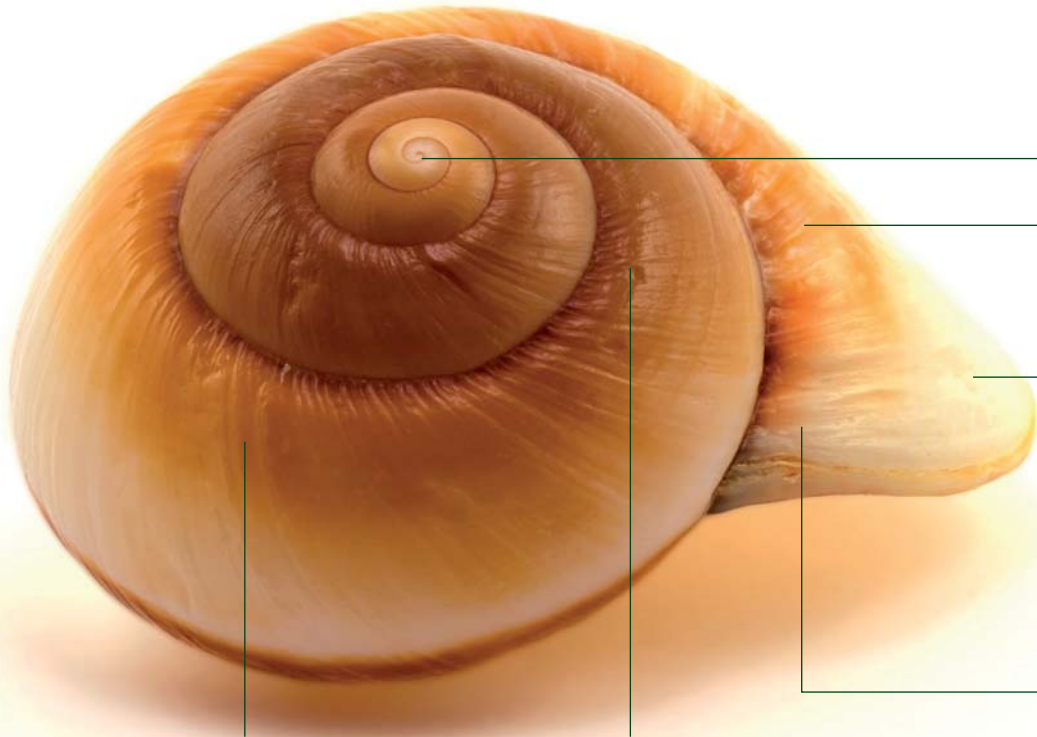

Qualità.
Ogni portone Breda nasce per essere unico. La progettazione viene effettuata con sistemi informatici che eliminano ogni imprevisto realizzativo. Il risultato è il migliore esempio di qualità totale che dura per sempre.

Quality.
Each Breda door is designed to be unique. The design is made through data processing which avoids any kind of unexpected events by the production. The result is the best total quality which will last forever.

Qualität.
Jedes Breda Sektionaltor ist ein Einzelstück. Die Planung wird, durch Präzisionsinstrumente durchgeführt, um eventuelle Verfahrungs-Fehler zu vermeiden. Das Ergebnis ist das beste Qualitätsbeispiel, das jahrelang dauert.

Norme e certificazioni.
Breda è azienda certificata UNI EN ISO 9001:2008 per la qualità e UNI EN ISO 14001:2004 per la gestione ambientale. Inoltre, tutti i prodotti possiedono il marchio CE previsto dalla Normativa Europea. Un'ulteriore garanzia di affidabilità e sicurezza.

Norms and certifications.
Breda is certified UNI EN ISO 9001:2008 for the quality and UNI EN ISO 14001:2004 for

the environment management. Moreover, all the products are guaranteed by CE certification in accordance to the European regulations. This is another guarantee of credibility and safety.

Normen und Zertifikate
Breda ist sowohl Qualität- als auch Umweltzertifiziert laut UNI EN ISO 9001:2008 und UNI EN ISO 14001:2004. Alle Tore sind laut europäische CE zertifiziert: eine zusätzliche Qualitätsgarantie.

Non ingombrante.

Un portone Breda si installa facilmente e in qualsiasi contesto. Il particolare sistema di scorrimento interno su guide che seguono il soffitto, richiede uno spazio davvero esiguo.

Not cumbersome.

A Breda sectional door is easy to be installed in in every contest. The particular internal sliding system on rails which follows the ceiling needs a really small space.

Kein Platzproblem.

Ein Breda Sektionaltor wird einfach in jeder Einbau-Situation montiert. Das originelle Gleitsystem braucht einen ganz geringen Raumbedarf.

Sicurezza.

Ogni portone sezionale Breda prevede una serie di sistemi di sicurezza come dotazione standard. Non a caso ogni realizzazione è il risultato di un processo produttivo altamente qualificato: a partire dalla progettazione, effettuata con strumenti informatici all'avanguardia, fino ai test di verifica effettuati su ciascun pezzo al fine di controllare, analizzare e accertare qualità e sicurezza.

Esteticamente perfetto e completamente personalizzabile.

I portoni sezionali Breda valorizzano l'ambiente in cui sono inseriti e soddisfano tutte le esigenze delle abitazioni contemporanee. Il design e le diverse soluzioni offerte, con le versioni in acciaio e legno, i diversi materiali, decorazioni, finiture e le infinite personalizzazioni possibili, permettono una perfetta integrazione in qualsiasi contesto architettonico.

Silenzioso e facile da utilizzare.

Un portone sezionale Breda si apre e si chiude con grande facilità. Tanti gli elementi che rendono immediato e confortevole l'utilizzo del portone: dalla possibilità di installare un piccolo motore "silenzioso" sul soffitto, al movimento controllato e reso sicuro dalla presenza di fotocellule, dal telecomando semplice e pratico alla luce di cortesia automatica.

Silent and easy to be used.

You can easily open and close a Breda sectional door. Several features make immediate and comfortable its use: the opportunity to install a little and "silent" motor on the ceiling, the controlled and

safe movement because of the presence of photocells, the remote control easy to be used and the automatic courtesy light.

Leicht und einfach zu benutzen.

Ein Breda Sektionaltor öffnet und schließt sich ganz leicht. Verschiedene Elemente machen die Nutzung einfach. Die Schlüsseleigenschaften: ein leiser Deckenantrieb, Sicherheits-Lichtschanke, ein kleiner und praktischer Handsender und automatische Innen-Licht.

Safety devices.

Each Breda sectional door includes a range of security systems as standard equipment. In fact every Breda product is the result of a highly skilled production process: starting from the design, made with advanced tools, to the verification tests performed on each component in order to monitor, analyze and verify the quality and safety.

Sicherheiten.

Jedes Breda Tor befriedigt alle Sicherheits-Normen, dank einiger Sicherheits-Vorrichtungen, die, serienmäßig geliefert werden. Jedes Produkt kommt aus hochqualifizierten Produktionsverfahren: von der Planung die, durch Präzisionsinstrumente durchgeführt wird, bis zur Qualitäts- u. Sicherheits-Kontrolle, auf jedem einzelnen Stück.

Aesthetically perfect and completely customizable.

The Breda sectional doors enhance the location in which they are inserted and meet all the needs of contemporary living. The design and the various solutions, with versions in steel and wood, the several materials, decorations, finishes and endless customization, enabling seamless integration into any architectural environment.

Ästhetische Vortrefflichkeit mit voller Personalisierung.

Die Breda Sektionaltore verschönern jede Einbau-Situation und befriedigen die Bedürfnisse der heutigen Wohntendenz. Design. Verschiedene Torversionen aus Stahl oder Holz. Mehrere, Materiale und Dekorationen. Unendliche Personalisierungsmöglichkeiten.



Breda Sistemi Industriali racchiude
valori e requisiti importanti di qualità, sicurezza
e cura estetica del prodotto.

Breda Sistemi Industriali meets
important requirements for quality, safety
and care product appearance.

Breda Sistemi Industriali enthält Qualität,
Sicherheit und ästhetische Produktpflege.

L'azienda è costantemente impegnata nello studio e nella ricerca di nuovi sistemi, materiali e tecnologie in grado di dare risposte alle esigenze estetiche, architettoniche e di praticità del vivere moderno. La capillarità sul territorio della rete vendita garantisce inoltre un servizio sempre veloce e competente, direttamente a domicilio. Scegliere Breda Sistemi Industriali significa scegliere sempre il meglio: tutti i prodotti sono sottoposti a specifici test di verifica per controllare e garantire qualità e sicurezza.

Company Breda is constantly engaged in studies and research of new materials and technologies to meet the aesthetic, architectural and practicality needs of modern living. The presence in the territory of the sales network grants a fast and competent service always directly at home. Choose Breda Sistemi Industriali means choosing always the best: all products are subject to specific tests to monitor and ensure quality and safety.

Immerwährend ist die Firma auf der Suche neuen Systeme, Materiale und Technologie, um die Bedürfnisse der heutigen Wohntendenz und architektonische Eigenschaften, zu befriedigen. Das Verkaufsnetz garantiert immer ein schnelles und kompetentes Service, frei Haus. Breda Sistemi Industriali bedeutet das Beste: zertifizierte und geprüfte Produkte, die Qualität und Sicherheit garantieren.



Tutte le possibilità per il tuo nuovo portone sezionale.

Configurazioni
Configurations
Zusammensetzung



Disegno lato esterno
External side drawing
Zeichnung von der aussenseite



Finitura lato esterno
External finish
Ausführung Aussenseite



Colori lato esterno
External colours
Farben der aussenseite



Oblò
Inspection windows
Bullaugen

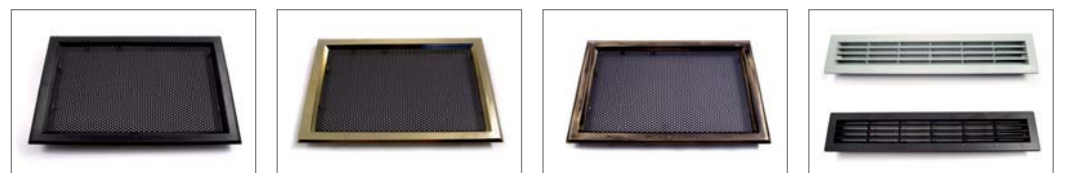

In ABS 525x350 con griglia di ventilazione, nero
ABS 525x350 black, with grill
Aus Aus ABS 525x350 mit Gitter, Schwarz

In ABS 525x350 con griglia di ventilazione, dorato
ABS 525x350 with grill, gold-plated
Aus Aus ABS 525x350 mit Gitter, vergoldet

In ABS 525x350 con griglia di ventilazione, bronzato
ABS 525x350 bronzed, with grill
Aus Aus ABS 525x350 mit Gitter, bronziert

Griglie di ventilazione
Ventilation grille
Lüftungsgitter

Maniglie
Handles
Griffe

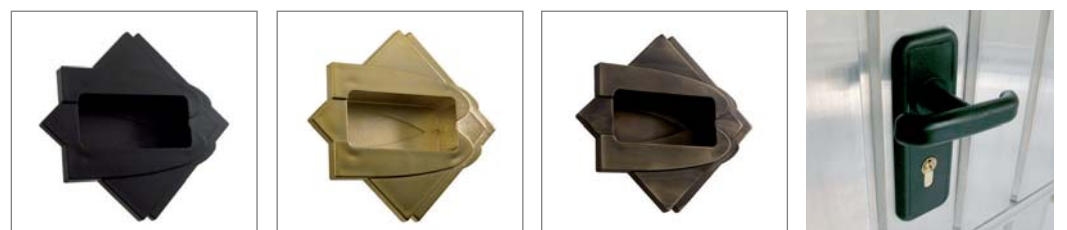

Nera/Black/Schwarz

Dorata/Gold-plated/Vergoldet

Bronzata/Bronzed/Bronziert

Nera/Black/Schwarz (Pegaso Doga)

Plus e sicurezze
Plus and safety devices
Plus und Sicherheiten



Cerniere verniciate non scalabili, in alluminio/Aluminium lacquered hinges, unclimbable/Lackierte und unersteigbare Scharniere, aus Aluminium (Wood Line)

Cerniere verniciate non scalabili, in alluminio/Aluminium lacquered hinges, unclimbable/Lackierte und unersteigbare Scharniere, aus Aluminium (Pegaso Line)

Mensole verniciate non scalabili, in alluminio/Aluminium lacquered brackets, unclimbable/Lackierte und unersteigbare Konsolle, aus Aluminium (Wood Line)

Mensole verniciate non scalabili, in alluminio/Aluminium lacquered brackets, unclimbable/Lackierte und unersteigbare Konsolle, aus Aluminium (Pegaso Line)

All options for your new sectional door. Alle Gestalte eines Tores.



Carterizzazione delle molle
Spring casing
Federschutz



Carterizzazione delle guide
Tracks cover
Schutzabdeckung für Laufschiene



Guide verniciate
Painted tracks
Lackierte Laufschienen



Omega di rinforzo
Omega reinforcing profile
Omega Verstärkungsprofil



Paracadute cavi (Wood Line)
Cable break safety device
Seilbruchsicherungsrichtung



Paracadute cavi (Pegaso Line)
Cable break safety device
Seilbruchsicherungsrichtung



Paracadute molle
Spring break safety device
Federbruchsicherungsrichtung



Trazione di sicurezza
Safety drive
Schlafseilsicherung



Rotelle a forbice
Scissors rollers
Tandemlaufrolle (Wood Line)



Rotelle a forbice
Scissors rollers
Tandemlaufrolle (Pegaso Line)



Molle zincate
Galvanized springs
Verzinkte Federn



Lampeggiante
Flashing light
Blinklicht



Fotocelle/Photocells
Lichtschranke

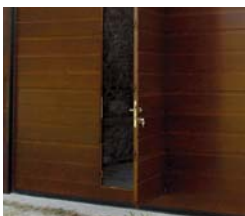

Porta pedonale/Pedestrian door
Schlupftür

Automazioni Motors Antriebe



Motore a traino/Pulling drive/
Deckenantrieb
V800E - V800E/D PLUS



Motore a traino/Pulling drive
motor/Deckenantrieb
SL550 - SL650 - SL800



Motore a traino SL 1100
Pulling drive motor SL 1100
Deckenantrieb SL 1100



Motore laterale STA1-STA3
Side direct drive STA1-STA3
Seitlicher Antrieb STA1 - STA3



Motore laterale CBX
Side direct drive CBX
Seitlicher Antrieb CBX

Telecomandi Remote controls Handsender



Telecomando per V800 e CBX
Remote control for V800 and CBX
Handsender für V800 und CBX



Telecomando per SL
Remote control for SL
Handsender für SL



Telecomando per STA
Remote control for STA
Handsender für STA



Breda: in ogni cosa che facciamo mettiamo
la testa e il cuore.

Breda: in everything we do we put
head and heart.

Breda: alles was wir tun, ist herzlich und
beruflich.

LA STRUTTURA DEL TUO PORTONE IN LEGNO.

I portoni delle linee Wood Line e Pegaso Line, sono costituiti da pannelli in compensato marino di Okoumè, legno originario dell'Africa equatoriale.

La sagoma anti pizzicamento brevettata, garantisce la sicurezza nel movimento del manto. La finitura del manto è garantita dall'applicazione di una mano di fondo di vernice impregnante e con due mani di finitura. I prodotti sono naturali e le vernici all'acqua, sull'onda della filosofia aziendale volta al rispetto dell'ambiente.

LA CURA DEL TUO PORTONE IN LEGNO.

La manutenzione è semplice si limita alla pulizia periodica mediante prodotti neutri tipo sapone di marsiglia ed all'applicazione di prodotti protettivi commerciali atti al mantenimento del legno esposto alle intemperie.

YOUR WOOD DOOR'S STRUCTURE.

The doors from Wood Line and Pegaso Line ranges are made with marine plywood Okoumè, a wood native on the equatorial Africa.

The patent anti-pinching profile grants the coat's safety movement.

The finishing is granted with the application of double coat transparent protective filler.

The products are natural and water painted, in accordance with the company philosophy of environment respect.

YOUR WOOD DOOR'S MAINTNANCE.

It's an easy maintenance, is requested a periodic cleaning with neutral products, as for example castile soap, and the application of protective products in order to save the wood exposed to weather conditions.

DER AUFBAU DEINES HOLZTORES.

Die Wood Line und Pegaso Line Tore, bestehen aus Sperrholz Okoumè, aus dem äquatorialen Afrika.

Die Fingeklemmschutz-Paneele garantieren die Sicherheit während der Torblattsbewegung. Die Ausführung des Torblattes besteht aus einmal Imprägnierungslack Anstrich und zweimal zusätzlichen Endlack.

Gemäß der umweltfreundlichen Firmenphilosophie, werden ausschließlich natur Produkte und Wasserlacke angewendet.

DIE PFLEGE DEINES HOLZTORES.

Die Wartung ist ganz leicht und begründet sich einfach auf die regelmäßige Reinigung, durch neutrale Reinigungsmittel, wie Marseille-Seife und die zusätzliche Anbringung von kommerziellen Holz-Erhaltungsprodukten, wegen der Aussetzung im schlechten Wetter.





La collezione di sezionali in legno che unisce
eccellenza, qualità della materia prima
e innovazione tecnologica per un risultato
unico ed esclusivo.

The collection of wooden sectional doors
which match excellence, raw material's
quality and technologic innovation, for a special
and exclusive final result.

Diese Holztor-Linie enthält Vollkommenheit,
Qualität und technologische Entwicklung,
für ein perfektes und exklusives Ergebnis.

Cinque modelli declinabili secondo svariate esigenze di dimensioni, finiture e funzionalità che consentono di arredare e di conferire all'abitazione uno stile inconfondibile, caratterizzato dalla suggestione estetica di un materiale nobile come il legno.

Five models which fit according to several needs of dimensions, finishing and functionality, in order to furnish with a special aesthetic style, granted by a noble material, as wood is.

Fünf Modelle für jeden Geschmack. Verschiedene Masse, Farbe und Eigenschaften. Der unverkennbare, adlige Stil des Holzes einrichtet das Haus, mit dem höchsten ästhetischen Geschmack.

Top / Civic / Polis / Gara / Disegni speciali

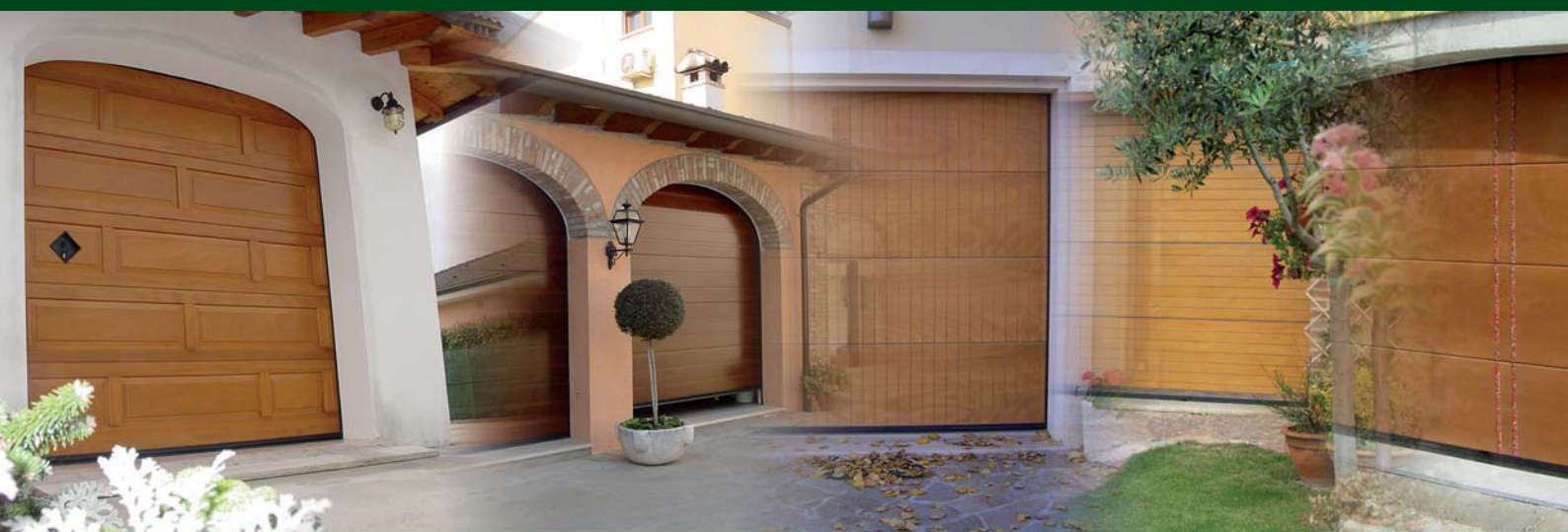



Wood Line / Top

Configurazioni
Configurations
Zusammensetzung



Il portone sezionale di punta della gamma è caratterizzato da pannelli di legno lavorati a specchio allineati o sfalsati. Top si distingue per la raffinatezza e la resistenza del legno Okoumè, che regala massimo stile ed eleganza al contesto abitativo in cui è inserito.

The main sectional door characterized by wooden panels with aligned or staggered blocks. Top distinguish itself by the refinement and the resistance of Okoumè wood, which grants a special style and elegance to the housing context.

Das Hauptmodell der Kollektion ist mit Holz-Kassettenpaneelen ausgestattet. Top ist ein gepflegtes und starkes Tor aus Okoumè Paneele, mit dem höchsten Stil und Eleganz.





BASE

Disegno lato esterno
 External side drawing
 Zeichnung von der aussenseite

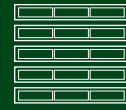

Cassetto
 With blocks
 Kassettenprägung

Colori e finiture lato esterno
 External colours and finishes
 Farben und Ausführung Aussenseite

Di serie/Standard/Serienmäßig



Impregnante neutro/Transparent filler
 Durchsichtige Imprägnierung

Optional



Noce chiaro/Light walnut/Heller Nussbaum

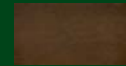

Noce scuro/Dark walnut/Dunkler Nussbaum



Douglas/Douglas/Douglas



Rovere chiaro/Light durmast/Heller Eichenholz



Rovere scuro/Dark durmast/Dunkler Eichenholz

Colori Optional
 Laccatura, verniciatura a campione
 Colours on request
 Lacquering, painting according to sample
 Sonderfarbe
 Lackierung nach Münster



BASE

Disegno lato esterno
External side drawing
Zeichnung von der aussenseite

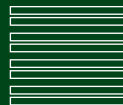
 Fresature orizzontali
Horizontal millings
Waagerechte
Fräsungen

Colori e finiture lato esterno
External colours and finishes
Farben und Ausführung Aussenseite

Di serie/Standard/Serienmäßig



Impregnante neutro/Transparent filler
Durchsichtige Imprägnierung

Optional



Noce chiaro/Light walnut/Heller Nussbaum

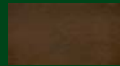

Noce scuro/Dark walnut/Dunkler Nussbaum



Douglas/Douglas/Douglas



Rovere chiaro/Light durmast/Heller Eichenholz



Rovere scuro/Dark durmast/Dunkler Eichenholz

Colori Optional
Laccatura, verniciatura a campione
Colours on request
Lacquering, painting according to sample
Sonderfarbe
Lackierung nach Muster



Configurazioni
Configurations
Zusammensetzung



Il sezionale che unisce tradizione e futuro. In Civic il fascino retrò del legno si fonde mirabilmente con le moderne esigenze stilistiche e abitative grazie alla possibilità di inserimento di vetrate e porte nella struttura del portone, con un occhio di riguardo alla massima innovazione tecnologica, marchio di fabbrica dei sezionali Breda.

The sectional which mix tradition and future. With Civic, you have the retro appeal of wood melt with the modern stylistic and housing needs thanks to the possibility of glazing sections and inserted pedestrian doors, with special care to the technologic innovation, the trade mark of Breda's sectional doors.

Tradition und Zukunft. Der Zauber des Holzes mischt sich mit den modernsten Wohnbedürfnissen: eingebaute Schluftpüre und durchsichtige Alu-Sektionen entsprechen die ausgesuchste Breda Technologie. Die Markenzeichen aller Breda Sektionaltore, deiner Verfügung.



Wood Line / Civic





Wood Line / Polis

Configurazioni
Configurations
Zusammensetzung

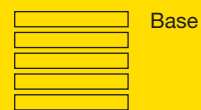

Nel portone sezionale Polis il calore, la qualità estetica e le magiche suggestioni africane del legno Okoumè vengono esaltate dalla particolare lavorazione dei pannelli con fresatura verticale. Il risultato è un concentrato di ricercatezza stilistica e massima resistenza nel tempo e agli agenti atmosferici.

On the sectional door Polis the warmth, the aesthetic quality and the magic African suggestions of Okoumè wood are enhanced by the particular processing on the panels, with the vertical millings. The result is a perfect mix of style and maximum time life, also against the atmospheric agents.



Besondere Senkrechte Fräsungen rühmen die ästhetischen Eigenschaften des zauberhaften, afrikanischen, Okoumè Holzes. Das Ergebnis ist eine Gesamtheit von Stil und langlebige wetterfeste Dauern.





BASE

Disegno lato esterno
 External side drawing
 Zeichnung von der aussenseite

 Fresature verticali
 Vertical millings
 Senkrechte Fräsungen

Colori e finiture lato esterno
 External colours and finishes
 Farben und Ausführung Aussenseite

Di serie/Standard/Serienmäßig



Impregnante neutro/Transparent filler
 Durchsichtige Imprägnierung

Optional



Noce chiaro/Light walnut/Heller Nussbaum

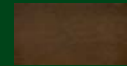

Noce scuro/Dark walnut/Dunkler Nussbaum



Douglas/Douglas/Douglas



Rovere chiaro/Light durmast/Heller Eichenholz



Rovere scuro/Dark durmast/Dunkler Eichenholz

Colori Optional
 Laccatura, verniciatura a campione
 Colours on request
 Lacquering, painting according to sample
 Sonderfarbe
 Lackierung nach Münster

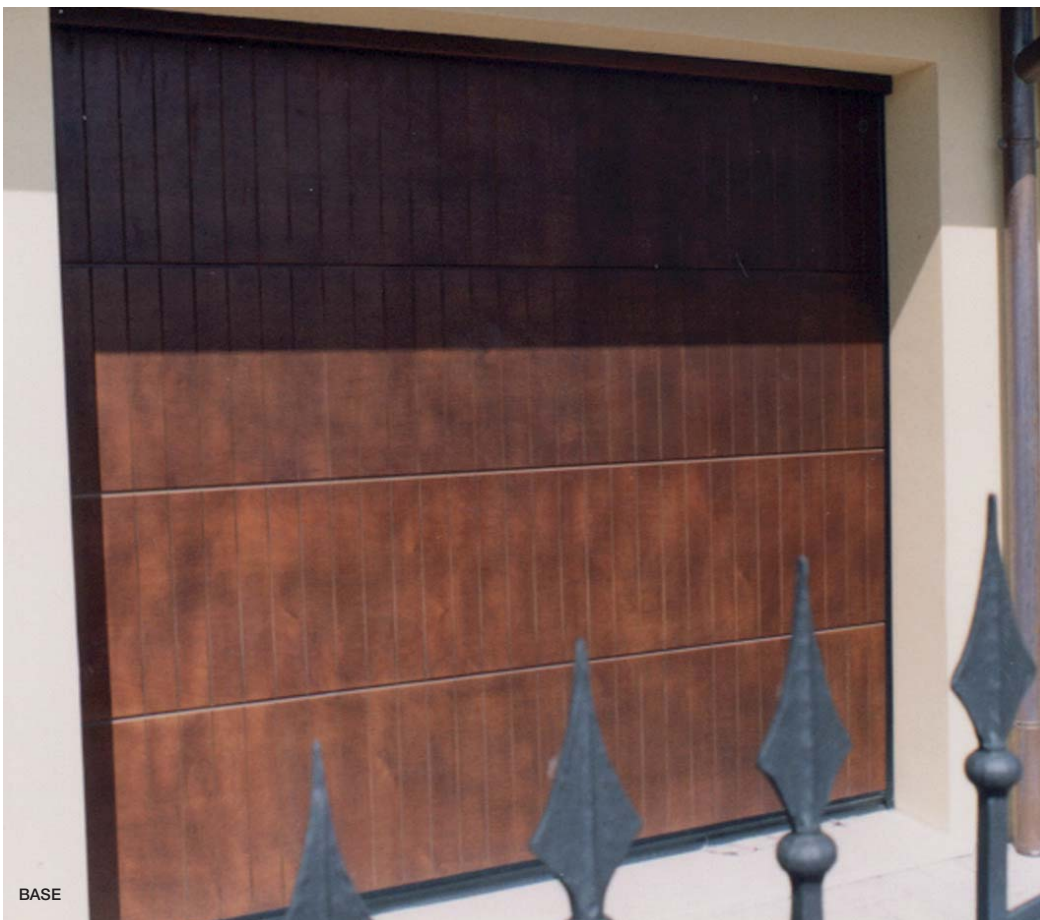

BASE

Disegno lato esterno
External side drawing
Zeichnung von der aussenseite



Fresature orizzontali
Horizontal millings
Waagerechte
Fräsungen

Colori e finiture lato esterno
External colours and finishes
Farben und Ausführung Aussenseite

Di serie/Standard/Serienmäßig



Impregnante neutro/Transparent filler
Durchsichtige Imprägnierung

Optional



Noce chiaro/Light walnut/Heller Nussbaum



Noce scuro/Dark walnut/Dunkler Nussbaum



Douglas/Douglas/Douglas



Rovere chiaro/Light durmast/Heller Eichenholz



Rovere scuro/Dark durmast/Dunkler Eichenholz

Colori Optional
Laccatura, verniciatura a campione
Colours on request
Lacquering, painting according to sample
Sonderfarbe
Lackierung nach Münster



BASE

Configurazioni
Configurations
Zusammensetzung

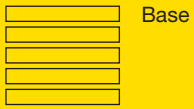

Base



Stop&Go

Gara, il sezionale che rappresenta la perfetta sintesi tra design, gusto estetico e un deciso ritorno alla materia. La lavorazione dei pannelli in multistrato marino del legno Okoumè con fresatura orizzontale donano uno stile sobrio, raffinato ed elegante a qualsiasi ambientazione in cui Gara è inserito.

Gara, the sectional which represents the perfect synthesis of design, aesthetic taste and simplicity. The processing of multi-ply Okoumé panels with horizontal millings grant a sober, refined and elegant style to every environment.

Die Perfekte Zusammenfassung zwischen Design und echte Schönheit der Materiale. Die Okoumè Schichtholz-Paneele, mit waagerechten Fräsungen, geben einen maßvollen Stil hin, in irgendwelcher Einbausituation.



Wood Line / Gara



BASE



BASE



BASE



Wood Line / Disegni speciali

Il modello Disegni Speciali by Breda offre una nuova interpretazione di creatività e stile applicati al portone sezionale grazie all'infinità possibilità di personalizzazione secondo il proprio gusto e la propria fantasia affinché esso possa adattarsi alla perfezione allo stile e alla tipicità della propria abitazione.

The model Disegni Speciali by Breda offers a new creativity and style performance on the sectional doors thanks to the possibility of customising according to the own taste and fantasy , with a perfect final harmony with the house.

Configurazioni
Configurations
Zusammensetzung



Das Modell mit Sonder-Motive bietet eine neue, originelle Tor-Darstellung: eine reiche Fräsungen-Vielfalt, personalisiert nach euerem Geschmack und Fantasie. Dieses Tor richtet sich, nach euerem Stil und Heim.



BASE



BASE



Design by Simone Micheli



Design by Simone Micheli

Disegno lato esterno
External side drawing
Zeichnung von der aussenseite

 Disegni speciali
Special drawings
Sonder-Motive

Colori e finiture lato esterno
External colours and finishes
Farben und Ausführung Aussenseite

Di serie/Standard/Serienmäßig



Impregnante neutro/Transparent filler
Durchsichtige Imprägnierung

Optional



Noce chiaro/Light walnut/Heller Nussbaum

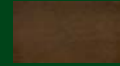

Noce scuro/Dark walnut/Dunkler Nussbaum



Douglas/Douglas/Douglas



Rovere chiaro/Light durmast/Heller Eichenholz



Rovere scuro/Dark durmast/Dunkler Eichenholz

Colori Optional
Laccatura, verniciatura a campione
Colours on request
Lacquering, painting according to sample
Sonderfarbe
Lackierung nach Münster



BASE



Pegaso Line, la linea di sezionali
in legno leggera, tecnologica e moderna.

Portoni che sono già leggenda.

Pegaso Line, the range of sectional made
with light, technologic and modern wood.

Doors which are already a legend!

Pegaso Line, die leichte, moderne
und technologische Holztor-Linie.

Ein Tor, eine Sage.

Tre modelli leggeri per natura, dove la struttura in alluminio e la tecnologia applicata reinterpretano al futuro l'antico fascino di un materiale nobile come il legno. Tre versioni pratiche, belle e funzionali con esclusivi sistemi di sicurezza e massima possibilità di personalizzazione per uno stile ineguagliabile nel segno di Breda.

Three light models, where the aluminium frame and technology enrich the old charm of a noble material as wood is. Three practical, beautiful and functional versions with exclusive safety systems and several personalization possibilities, with a final inimitable style, the Breda ones!

Die Leichtigkeit dieses Konzept steht in der Alu-Struktur und in der Technologie, die, zusammen, stellen den antiken und adligen Zauber des Holzes dar. Drei schönen, zweckmäßige und praktische Versionen mit ausgezeichnete Sicherheitsvorrichtungen und Personalisierungsmöglichkeiten, in dem unvergleichbaren Breda-Style.

Pegaso Standard / Pegaso Special / Pegaso Doga



Disegno lato esterno
External side drawing
Zeichnung von der aussenseite

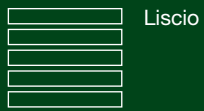

Liscio

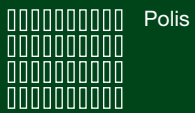

Polis

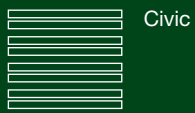

Civic



Gara

Colori e finiture lato esterno
External colours and finishes
Farben und Ausführung Aussenseite

Di serie/Standard/Serienmäßig



Impregnante neutro/Transparent filler
Durchsichtige Imprägnierung

Optional



Noce chiaro/Light walnut/Heller Nussbaum



Noce scuro/Dark walnut/Dunkler Nussbaum



Douglas/Douglas/Douglas



Rovere chiaro/Light durmast/Heller Eichenholz



Rovere scuro/Dark durmast/Dunkler Eichenholz

Colori Optional
 Laccatura, verniciatura a campione
Colours on request
Lacquering, painting according to sample
Sonderfarbe
Lackierung nach Münster



Disegno GARA



Lato interno

Configurazioni
Configurations
Zusammensetzung



Pegaso Line / Pegaso standard

Pegaso Standard, il must della linea Pegaso dall'elegante gusto estetico che garantisce una insolita e quantomai importante combinazione tra leggerezza strutturale e requisiti di robustezza e di resistenza nel tempo superiori alla norma. La versione standard garantisce inoltre la possibilità di coordinare le finiture dei pannelli di legno Okoumè con il resto dei serramenti della propria abitazione.

Pegaso Standard, the must from Pegaso range with an elegant aesthetic taste, which grants a special combination of structural lightness and at the same time strength and resistance, above the normal. The standard version grants also the best combination between the finishing of the wood Okoumè panels with all the frames of the house.

Pegaso Standard, der „must“ der Pegaso Line. Der elegante, ästhetische Geschmack erlaubt eine wichtige Zusammenstellung zwischen der Leichtigkeit der Struktur und der jahrelangen Haltbarkeit. Die standard Version gibt die Möglichkeit dazu, die Okoumèholz-Paneele mit den Hausfenster und Türe, zu kombinieren.



Disegno POLIS



Disegno LISCIO



Disegno CIVIC



Disegno GARA



Pegaso Line / Pegaso special

La versione Special di Pegaso Line è un inno alla fantasia e alla creatività grazie all'ampia possibilità di personalizzazione dei disegni, delle finiture e delle lavorazioni che lo rendono facilmente adattabile a qualsiasi contesto abitativo.

The version Special from Pegaso Line is a must of fantasy and creativity thanks to the several possibilities of personalisation, with drawings, several finishing and processing which grant a perfect adaptability to all the home contexts.

Configurazioni
Configurations
Zusammensetzung



Die Special Version der Pegaso Line ist das Höchstmaß der Fantasie und Kreativität, dank der Vielfalt der Personalisierungen, durch Zeichnungen, Farbe und Fertigungen. Dieses Tor fügt sich in irgendwelcher Einbausituation ein.



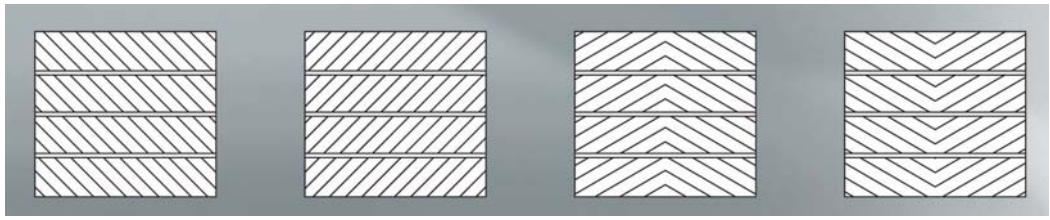

Azalea

Arcalia

Crocus

Camelia

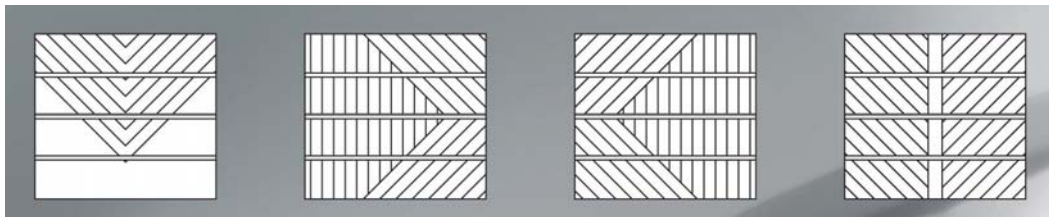

Fresia

Ortensia

Orchidea

Viola

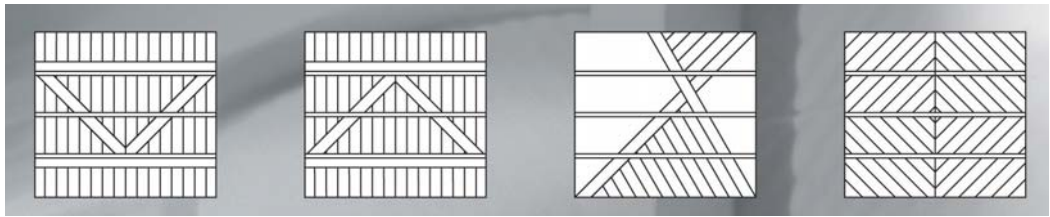

Loto

Lilla

Begonia

Dalia

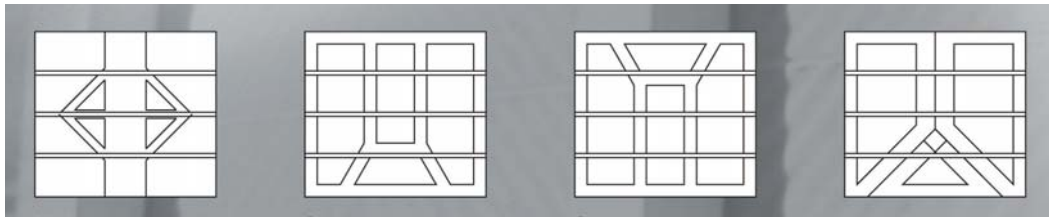

Ninfea

Gerbera

Giglio

Petunia

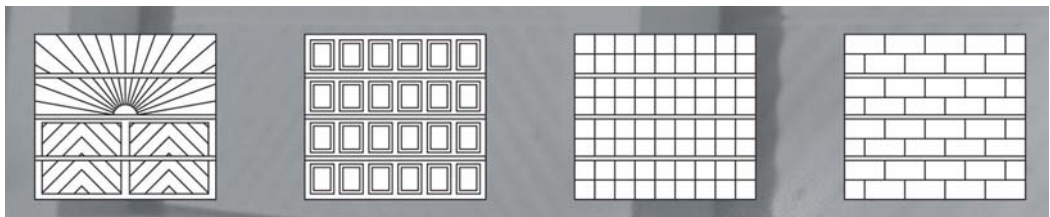

Aster

Glicine

Mimosa

Rosa

Disegno lato esterno
External side drawing
 Zeichnung von der aussenseite

 Disegni speciali
Special drawings
 Sonder-Motive

Colori e finiture lato esterno
External colours and finishes
 Farben und Ausführung Aussenseite

Di serie/Standard/Serienmäßig

 Impregnante neutro/Transparent filler
 Durchsichtige Imprägnierung

Optional

 Noce chiaro/Light walnut/Heller Nussbaum

 Noce scuro/Dark walnut/Dunkler Nussbaum



 Douglas/Douglas/Douglas

 Rovere chiaro/Light durmast/Heller Eichenholz

 Rovere scuro/Dark durmast/Dunkler Eichenholz

Colori Optional
 Laccatura, verniciatura a campione
Colours on request
 Lacquering, painting according to sample
 Sonderfarbe
 Lackierung nach Münster

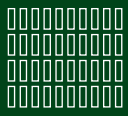
Disegno lato esterno
External side drawing
Zeichnung von der aussenseite



Verticale
Vertical
Vertikal



Orizzontale
Horizontal
Horizontal

Colori telaio e doghe in Alluminio lato esterno/
Colours of frame and aluminium ribs, external side
Alu-Rahmen und Alu-Dauben
Außenfarbe



Ossidato naturale
Natural anodised
Natur oxydiert



C21



C17



RAL 6005



RAL 6009

Colori Optional
Tabella RAL Breda
Optional colours
Breda's RAL Colour Chart
Extra Farben
Breda RAL-Farbvorlage



Verticale/Vertical/Vertikal



Verticale/Vertical/Vertikal

Configurazioni
Configurations
Zusammensetzung

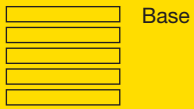

Pegaso Line / Pegaso doga

Portone sezionale realizzato con speciali profilati in alluminio e applicazione di doghe disponibili nella versione verticale e, di recente, anche orizzontale dallo spessore di 12 mm, per regalare un insieme di armonia strutturale e di forte linearità. Elevati standard tecnologici e di sicurezza fanno di Pegaso Doga la soluzione ideale per qualsiasi abitazione.

A sectional door made with special aluminium profiles and vertical ribs, of late also horizontal, with 12 mm thickness, to grant a final harmonic structural and linear result. The high technologic and safety standards make Pegaso Doga the ideal solution in every house.

Dieses Sektionaltor besteht aus besonderen Alu-Profilen, mit senkrechte oder waagerechte 12mm Dauben, für eine harmonische und lineare Zusammenstellung. Pegaso Doga, dank seiner Sicherheitsvorrichtungen, passt zu jedem Hausstill an.



Verticale/Vertical/Vertikal



Orizzontale/Horizontal/Horizontal

**SIAMO SEMPRE ON LINE
WE ARE ALWAYS ON LINE
WIR SIND IMMER ON LINE**



RIVENDITORI E INSTALLATORI BREDa, TIPI DAVVERO SPECIALI.

Formiamo i nostri rivenditori e installatori con corsi di specializzazione periodici per trasferire tutta la conoscenza e l'innovazione tecnologica che introduciamo nei nostri prodotti. I Rivenditori e gli Installatori Breda hanno davvero una marcia in più. Chiedete sempre il loro consiglio. Cerca il più vicino a te sul sito e se vuoi vedere qualche realizzazione digita: www.bredasys.com/Mappa-Portoni-Breda/
www.bredasys.com/Contatti.htm

FAI LA SCELTA MIGLIORE: per il tuo portone residenziale, chiedi consiglio al tuo Rivenditore Breda, l'unico esperto in grado di capire le tue esigenze di spazio e i tuoi gusti.
Se non lo hai ancora trovato vai su: www.bredasys.com/Rete-Vendita-Breda/

DEALERS AND INSTALLERS BREDa, VERY SPECIAL PEOPLE.

We train periodically our Dealers and Installers with specialized courses to transfer all the knowledge and technological innovation that we introduce in our products. Dealers and Installers Breda really have something extra. Always ask for their advice. Find a dealer near you on the site and if you want to see some examples of door Breda in the reality, type: www.bredasys.com/EN/Contatti.htm

MAKE THE BEST CHOICE: ask your Dealer Breda for your residential garage door.
He's the only expert able to understand your space needs and your tastes.
If you haven't found him, go on: www.bredasys.com/EN/dealers

BREDa HÄNDLER UND MONTEURE, WIRKLICH SONDERPERSONEN.

Wir bilden unsere Händler und Monteure durch periodische Spezialisierung- Kurse um die Kenntnis und die technologische Erneuerung, die wir in unsere Produkte einführen, zu versetzen. Die Breda Händler und Monteure sind wirklich sonder. Immer frage nach Ihrem Ratschlag. Finde den näheren auf der Web-Site und wenn du möchtest einige Durchführung sehen click: www.bredasys.com/DE/Contatti.htm

MACH MAL DIE BESTE WAHL!: für dein Haustor frag mal bitte deinem Breda Händler. Er kennt genau deinen Geschmack und Bedürfnisse. Falls du ihn noch nicht gefunden hast, wirf bitte einen Blick auf www.bredasys.com/DE/Verkaufsnetz

Tabella scorrimenti portoni sezionali / *Sliding systems for sectional doors / Beschläge für Sektionaltore*

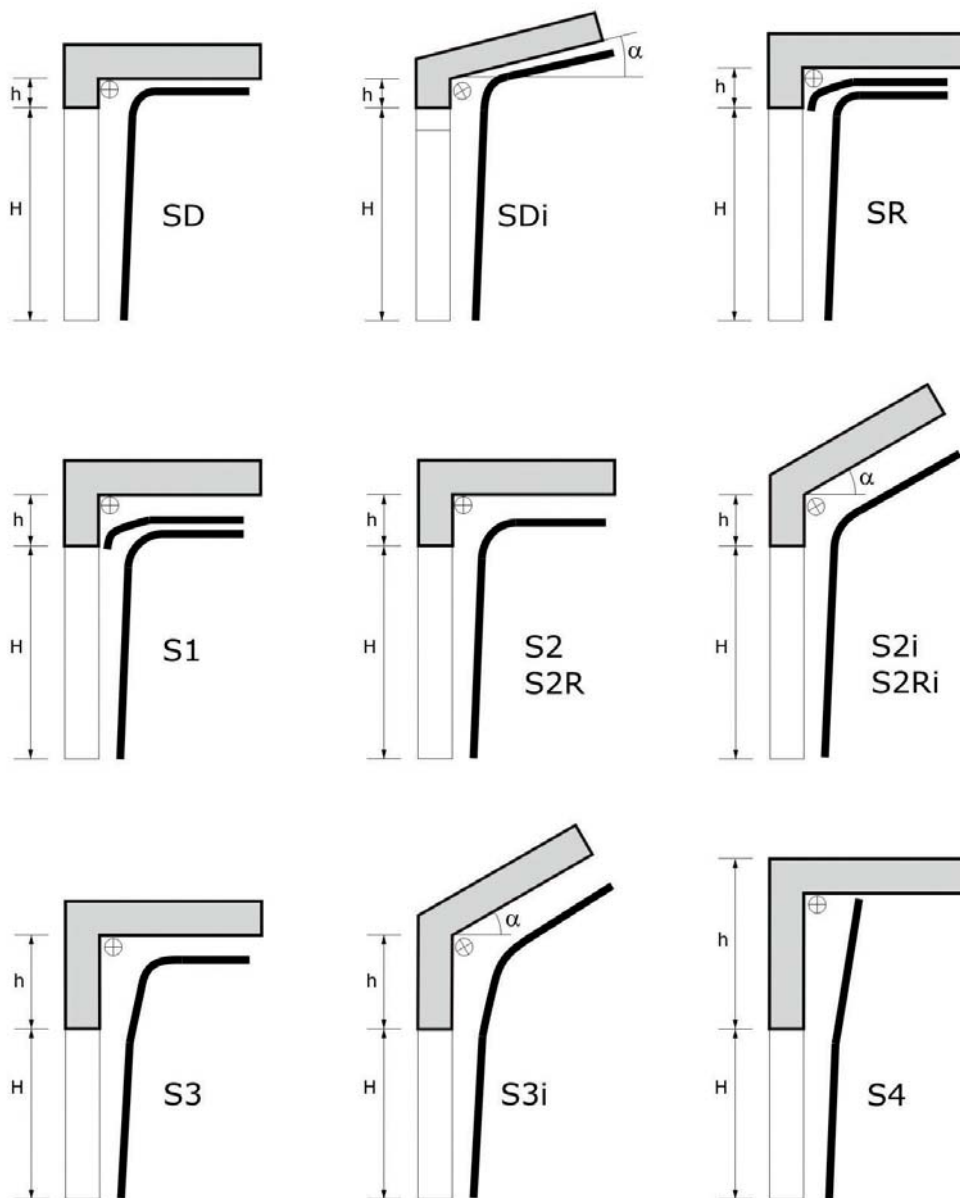

Le informazioni riportate hanno valore puramente indicativo e possono in qualsiasi momento essere modificate dalla Breda Sistemi Industriali S.p.A. I colori raffigurati sono puramente indicativi.

The information here is used purely as a suggestion and Breda reserves the unappealable right to change it at anytime. The colours represented here are used purely as a suggestion.

Die hier aufgeführten Informationen dienen nur der Erläuterung und können von der Firma Breda jederzeit geändert werden, wobei diese das unanfechtbare Recht hat, Modifikationen vorzunehmen. Die dargestellten Farben dienen lediglich der Veranschaulichung.

Progetto e concept: page,
Testi: Luca Drigani/Laura Menis
Coordinamento: carterandbennett.com
Stampa: Areagrafica

Ottobre 2012

Breda è anche/Breda is also/Breda ist auch:

- Portoni Residenziali/*Residential Doors/Sektionaltore für Wohnbereich*
- Chiusure industriali/*Industrial doors/Industrietore* • Le Perle



Li trovi sul nostro sito/*Find them in our website/Finden Sie auf unserer Website* www.bredasys.com

Breda Sistemi Industriali S.p.A.
Via Cecilia Danieli, 2 - 33090 Sequals - PN - Italy
Tel +39 0427 939311 - Fax +39 0427 939321
breda@bredasys.com - www.bredasys.com



BREDA[®]
S I S T E M I INDUSTRIALI
PORTONI SEZIONALI EVOLUTI