

# OVERLAP

TRACKLESS SECTIONAL DOOR

**SILVELOX**  
devoted to design

# OVERLAP TECHNOLOGY

innovative design

## OVERLAP TECHNOLOGY: PATENTED QUALITY

Silvelox bases its business on research and development aiming towards technological innovation, presenting to the market always cutting-edge products.

OVERLAP TECHNOLOGY is the perfect combination of an innovative opening system with an optimal functional and aesthetic result.

## TABLE OF CONTENT

### 4 + **MORE THAN 50 YEARS OF INNOVATION**

Silvelox presentation

### 6 + **DESIGN**

Silvelox makes your ideas happen

### 10 + **DESIGN**

Silvelox reinvents the garage door

### 12 + **SPACE TO YOUR SPACE**

OVERLAP opening system

### 14 + **DIFFERENCES + ADVANTAGES**

Comparison between traditional and OVERLAP sectional door

### 16 + **REASONS TO CHOOSE OVERLAP**

When technology serves beauty

### 18 + **MODERNITY + SIMPLICITY**

Wood and Metal

### 22 + **CUSTOMIZATION**

Choosing among 12 models

### 36 + **BRIGHTNESS AND VENTILATION**

Windows, grids, cover boards and transoms

### 38 + **COMBINATIONS**

Woods and colours

### 41 + **OPTIONS**

Handles

### 46 + **FLEXIBILITY IN INSTALLATION**

Flush installation and behind wall installation

### 51 + **SIZE**

Door sizes and models

### 57 **TECH SPECS**



Door: Velox 1961

**SILVELOX**  
devoted to design

**“Inventing is my obsession”**

(Silvio Taddei - the founder)

# + MORE THAN 50 YEARS OF INNOVATION

SILVELOX was founded in 1961 by Silvio Taddei's innovative idea to create a self-lifting garage door, unique and revolutionary in the residential door industry. Innovation has characterized the entire Silvelox existence, which has always been dedicated to the design intended as the research both for technological solutions and beauty. The new product of this ongoing research is OVERLAP: a garage door with an innovative mechanics that redefines the state-of-the-art for residential doors.



WHY SILVELOX?

# + DESIGN



## SILVELOX MAKES YOUR IDEAS HAPPEN

Each Silvelox door is a unique product because it is custom made and it is the result of one of the infinite possible combinations of materials, stains, colors, models and accessories. The high degree of flexibility of Silvelox allows a Complete product customization due to an industrial production that combines the technological ability with craftsmanship. Our design team supports customers in with specific solutions from both technical and an aesthetic point of view.

**THIS IS NOT  
JUST A  
GARAGE DOOR**



**IT IS MUCH MORE +**

## SILVELOX REINVENTS THE GARAGE DOOR

OVERLAP is the only sectional garage door without ceiling tracks, without springs, with a double counterweight mechanism and the operator embedded in the head-bar. It is the ideal product to enhance the garage and allows space optimization due to reduced internal dimensions. OVERLAP is born from the commitment of Silvelox to combine technology and beauty for the residential market, providing attention to the smallest details and an extensive customization options, unlike the traditional sectional door that is born to meet the needs of commercial and industrial buildings. OVERLAP, like all Silvelox products, is a genuine Made in Italy example that embodies quality, design and technology.

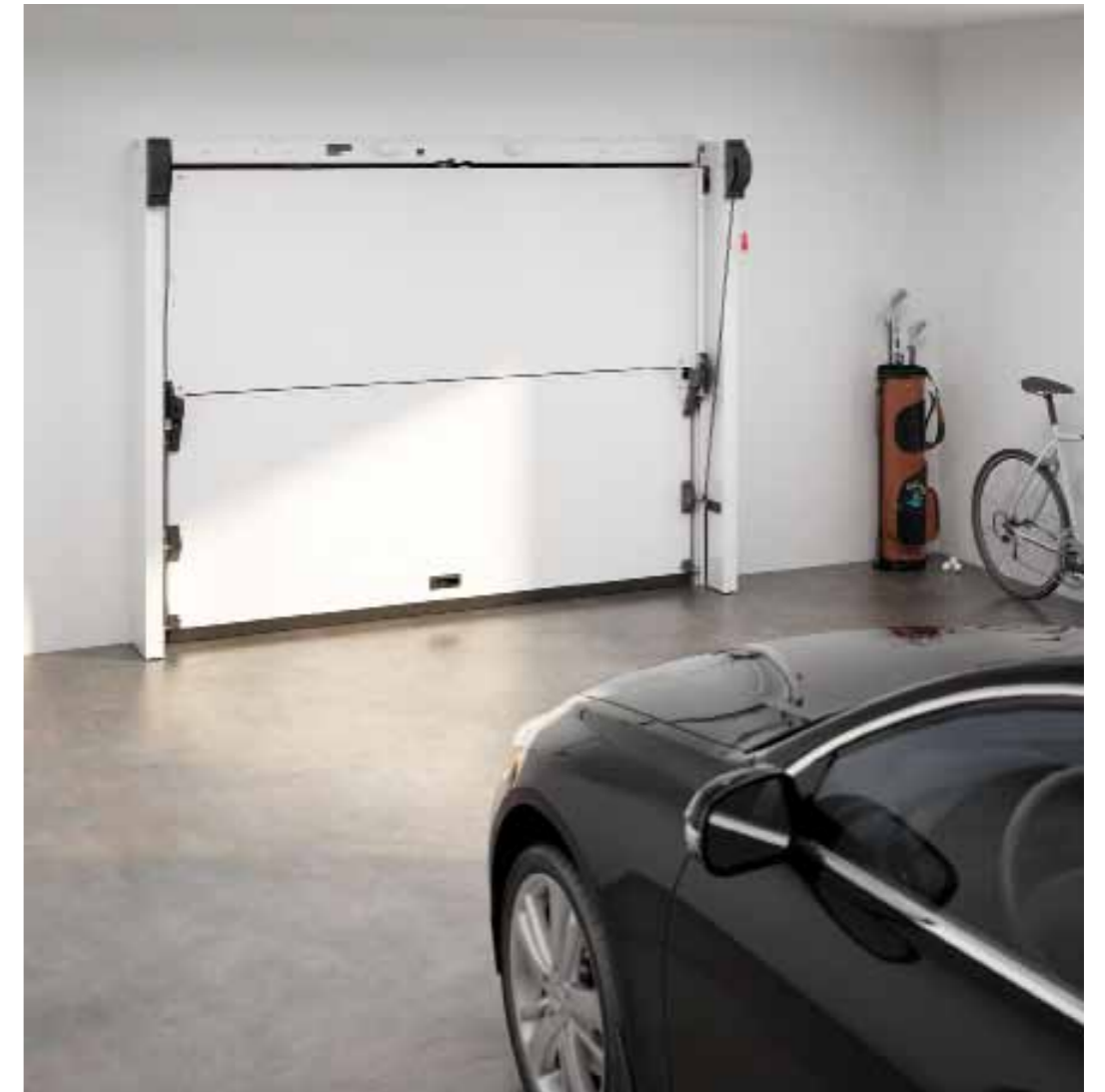

Internal view

**+** DESIGN

**+ SPACE**  
TO YOUR SPACE

## MINIMAL DIMENSIONS MAXIMAL OPENING

OVERLAP is an innovative sectional door thanks to its patented opening system that does not require ceiling tracks and cuts by 50% the internal dimensions. With OVERLAP the space inside the garage is best used and the door clearance is optimized, both in height and

in width. Just a 200 mm headroom is required. OVERLAP is equipped with the Silvelox operator embedded in the headbar. This system operates the door without visible ceiling tracks.



Watch OVERLAP  
video!

### OVERLAP OPERATION:

The door raises, folds in half, turns below the ceiling, splits in two sections and the lower one slides below the upper one.

# + DIFFERENCES

TRADITIONAL  
SECTIONAL  
DOOR



- 1** **CEILING TRACKS:**  
The vertical sliding movement implies that the door, when open, lies parallel to the ceiling supported by the tracks that remain always in sight, fixed to the ceiling, even with the door closed.
- 2** **VISIBLE OPERATOR:**  
The operator is anchored to the ceiling with an increment of required space.
- 3** **SPRING SYSTEM:**  
The door is balanced by a spring system. It requires periodical inspections and replacements.
- 4** **INTERNAL SIDE:**  
The multiple horizontal sections architecture involves the use of visible hinges and hardware.

# + ADVANTAGES

OVERLAP  
SECTIONAL  
DOOR



- 1** **TRACKLESS:**  
This is the main feature that makes OVERLAP unique. Thanks to its supporting frame and its two overlapping sections, unpleasant ceiling tracks are not necessary.
- 2** **INVISIBLE OPERATOR:**  
The operator is completely hidden inside the head-bar; it does not require sliding bars and it does not need additional space.
- 3** **COUNTERBALANCE SYSTEM:**  
The two sections are balanced by means of a counterweight system. Parts subject to wear are minimized.
- 4** **INTERNAL SIDE:**  
Due to the unique architecture, the internal side result is clean with no hardware.



WHEN TECHNOLOGY  
SERVES BEAUTY



**MORE SPACE WITH NO  
CEILING TRACKS**



**CLEAN VIEW WITH  
HIDDEN OPERATOR**



**EVERLASTING  
COUNTERBALANCE SYSTEM**



**BEAUTY ON BOTH SIDES**

# + REASONS

TO CHOOSE OVERLAP

**OVERLAP  
TECHNOLOGY**  
innovative design

OVERLAP has been studied and created on the basis of OVERLAP TECHNOLOGY, patented system finalized to maximize functionality and aesthetics. OVERLAP TECHNOLOGY allows to adapt the door to any type of construction requirements and makes it the first "business card" of the house.

# + MODERNITY



WOOD

## NATURE LIVES IN DESIGN

Wood, natural design element, is used with wisdom and deep respect for nature and provides all the warmth and the finish quality that characterize Silvelox products. Special processing techniques and the use of noble essences make possible a wide range of aesthetic finishes and combinations.

The use of wood is carried completely in compliance with eco-friendly procedures.



# + SIMPLICITY



METAL

## METAL JOINS WOOD

Metal responds to the simplicity and minimalism needs of many contemporary architectural contexts, giving the door a sober and essential look. The metal version is available in a range of finishes aligned with actual market offer and requires a different maintenance over time.



# + ELEGANCE

## BEAUTY WITH NO SHADOWS

The same attention to details that characterizes the outside of the door is also applied to the inner side. The absence of ceiling tracks and the minimalism of the interior give a sense of cleaning and rigor. The operator is embedded in the head-bar and does not require sliding bars or other functional elements on sight. The inside looks white colored; upon customer request, the panels can be customized and take the same color as the outer side.

EXTERNAL  
VIEW



INTERNAL  
VIEW



Internal view, RAL 9016 standard color



Custom internal view, available upon request

# + CUSTOMIZATION

# + MODELS + CHOICE

Overlap is available in a wide range of models, spanning from traditional vertical line decorations to sophisticated geometric combinations and wood grain effects. It is offered in different stains on various woods or lacquered in different RAL colors both standard and of your choice. The metal coated version is available in models DUO, EMI and SIX in various finishes and colors, as well as in wood look.

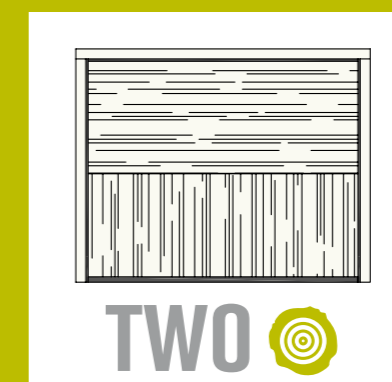
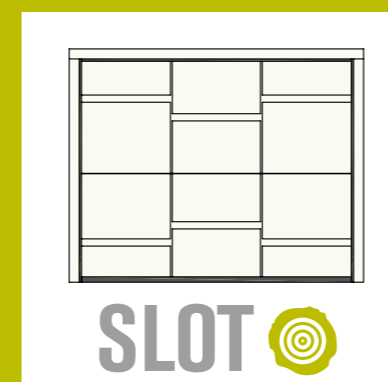
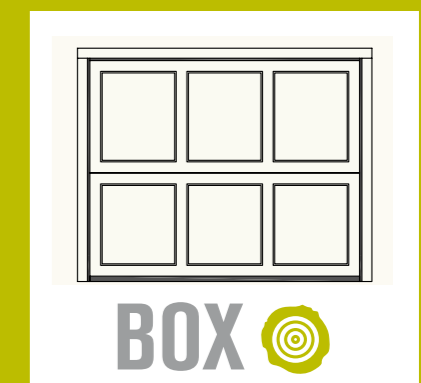
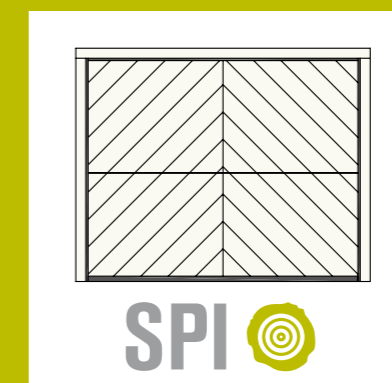
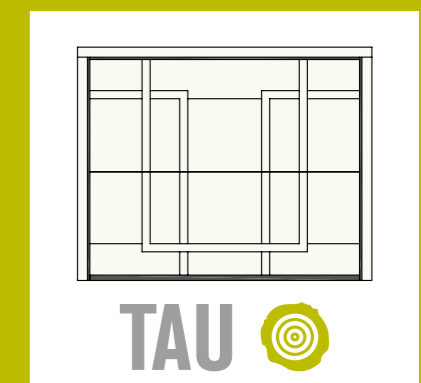
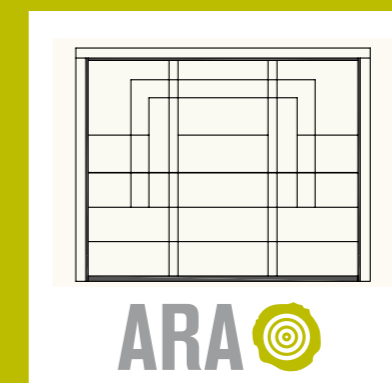
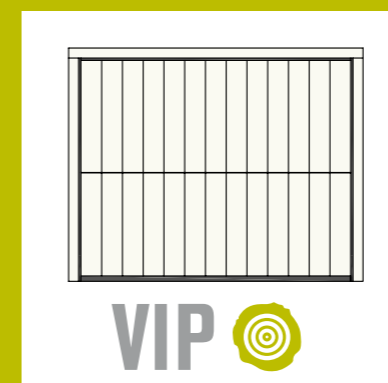
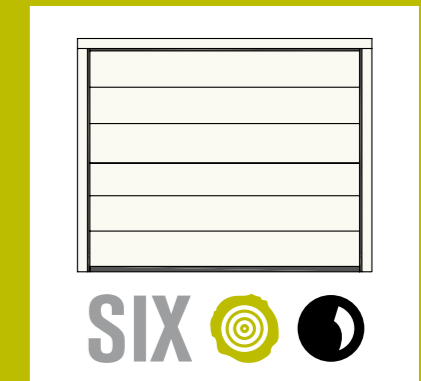
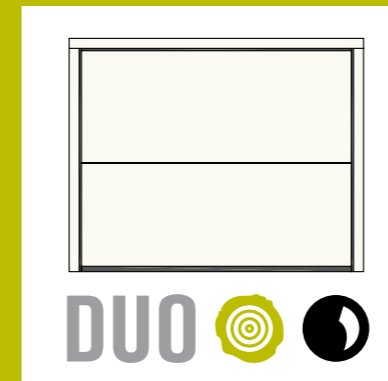

Drawings referred to a W 3270 mm by H 2580 mm door.  
Other door sizes imply proportional drawing variations.



1 / 12

+ MODELS  
**DUO**    
 WOOD METAL

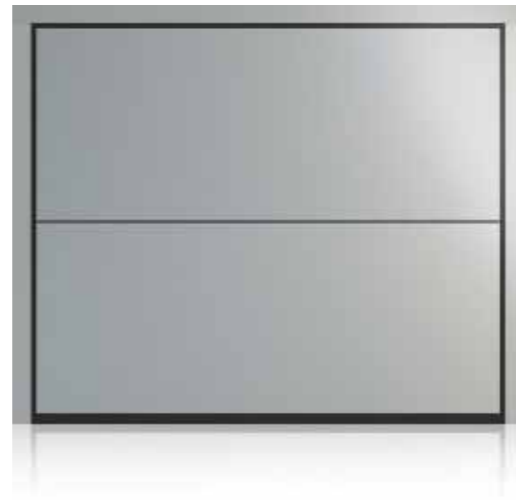
Minimal decoration for maximum simplicity.



2 / 12

+ MODELS  
**EMI**    
 WOOD METAL

Horizontal lines as in traditional sectional doors.



DUO Model – Laquered okumè, RAL 9006 White Aluminum



EMI Model – Impregnated okumè, Honey

+ MODELS  
**SIX**    
 WOOD METAL

Horizontal lines for an enhanced look.



+ MODELS  
**VIP**   
 WOOD

Evergreen classic in sign of tradition.

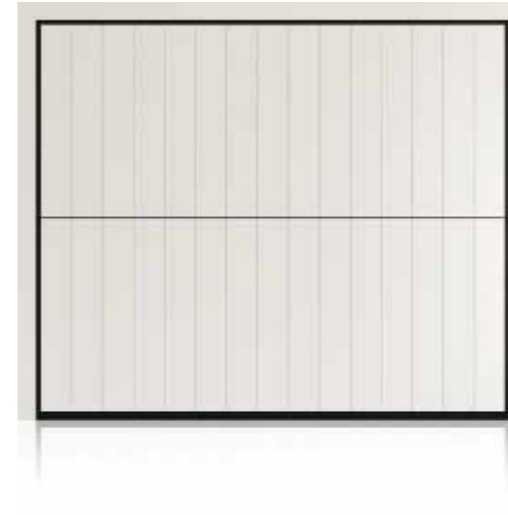

SIX Model – Embossed metal coating, RAL 7016 Anthracite Grey



VIP Model – Laquered okumè, RAL 9016 Traffic White

+ MODELS  
**ARA**  
WOOD

Harmonic geometric combination for a creative design.



+ MODELS  
**TAU**  
WOOD

Elegant intersection of lines for a design full of originality.



ARA Model – Laquered okumè, RAL 5003 Sapphire Blue



TAU Model – Teak with pigmented varnish

+ MODELS  
**GEO**  
WOOD

A mix of horizontal and vertical lines for an advanced creation.



GEO Model – Laquered okumè, RAL 8016 Mahogany Brown

+ MODELS  
**SPI**  
WOOD

Herringbone lines for a traditional visual effect.

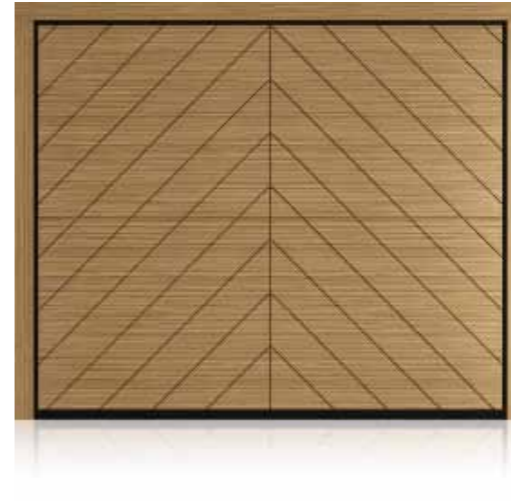

SPI Model – Larch with pigmented varnish



+ MODELS  
**BOX** 

Simple but strong personality.



+ MODELS  
**SLOT** 

Distinctive bas-reliefs combination.



BOX Model – Laquered okumè, RAL 7040 Window Grey



SLOT Model – Laquered okumè, RAL 7044 Silk Grey

+ MODELS  
**TWO** 

Pleasant horizontal and vertical veneering combination.



+ MODELS  
**TEX** 

Refined effect through the combination of veneering and precious woods.



TWO Model – Brushed larch Sand



TEX Model – Brushed larch with pigmented varnish

# + BRIGHTNESS

## AND VENTILATION

### WINDOWS AND GRIDS

OVERLAP is also available with a wide range of glazing options that allow you to illuminate the garage interior with natural light and to lighten the visual impact of the door. The OVERLAP windows are made of polycarbonate, lightweight and durable material available with bronze embossed finish and, on request, clear embossed or smooth transparent finishes. If the garage needs ventilation, it is possible to add ventilation grids or circular slits to OVERLAP.



Bronze embossed (default)

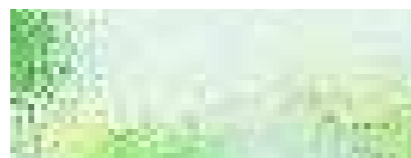

Clear embossed



Smooth transparent



Cover boards



Transoms

### COVER BOARDS AND TRANSOMS

When the full opening height is not required you can choose either a glazed or timber transom.

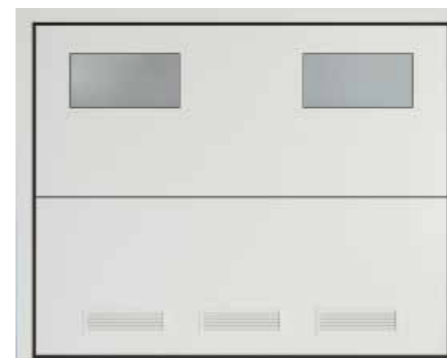

Door with 2 fixed windows, measuring W 800 mm by H 400 mm each, with double polycarbonate sheet bronze embossed and 3 rectangular ventilation grids, measuring W 600 mm x H 200 mm, in plastic material, Traffic White RAL 9016 color. Drawing referred to a W 3270 mm by H 2580 mm door.

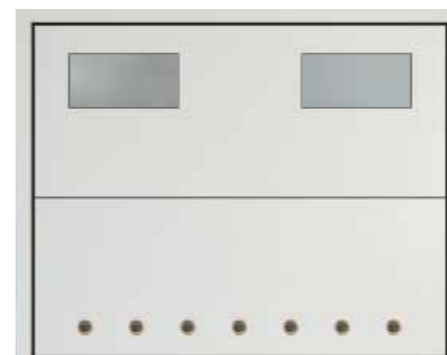

Door with 2 fixed windows, measuring W 800 mm by H 400 mm each, with double polycarbonate sheet bronze embossed and row of circular ventilation grids, having a 120 mm diameter, Auburn color. Drawing referred to a W 3270 mm by H 2580 mm door.



Door with 2 rows of circular ventilation grids, having a 120 mm diameter, Auburn color. Drawing referred to a W 3270 mm by H 2580 mm door.



Door with 5 rectangular ventilation grids, measuring W 600 mm x H 200 mm, in plastic material, Traffic White RAL 9016 color. Drawing referred to a W 3270 mm by H 2580 mm door.

The fixed windows are made with double polycarbonate sheet 6 mm thick, embossed Bronze (on request embossed clear or transparent smooth) with a width of 200, 400, 600 or 800 mm and height of 200, 300 or 400 mm. The rectangular grids of ventilation are made in plastic material, aluminum RAL 9006 color (available on request painted in other 14 RAL colors) and are sized 400 x 200 mm (ventilation surface 250 cm<sup>2</sup>) or 600 x 200 mm (ventilation surface of 390 cm<sup>2</sup>). The circular ventilation grids have a coppery color, diameter 120 mm with an area of aeration equal to 42 cm<sup>2</sup> each. The windows and the grids are not feasible in the center of the top panel for doors with handles.

# + COMBINATIONS

OVERLAP is made by 75 mm thick Multi-ecowood panels with wood or metal coating, available in a wide range of variations and finishes.



	OKOUMÉ	NORTHERN SPRUCE	OAK
Honey			
Oak			
Douglas			
Cherry			
Mahogany			
Walnut			



## LARCHES

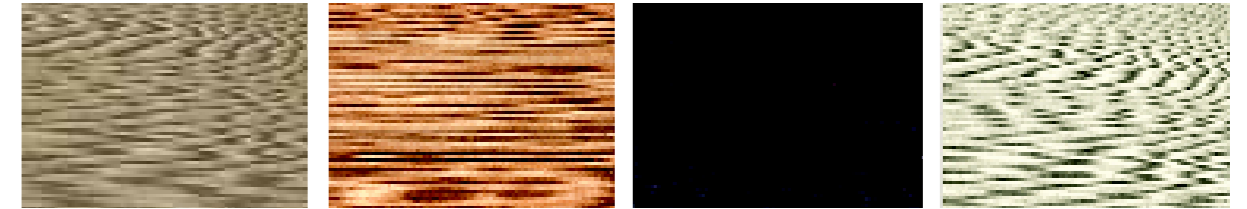

Brushed Tortora

Brushed Naturale

Brushed Black

Brushed Sabbia

## TEAK

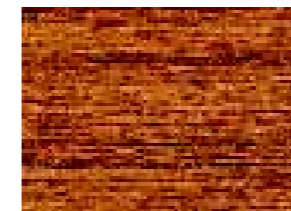

Pigmented Varnish

## LARCHES



Pigmented Varnish

## LAQUERED RAL

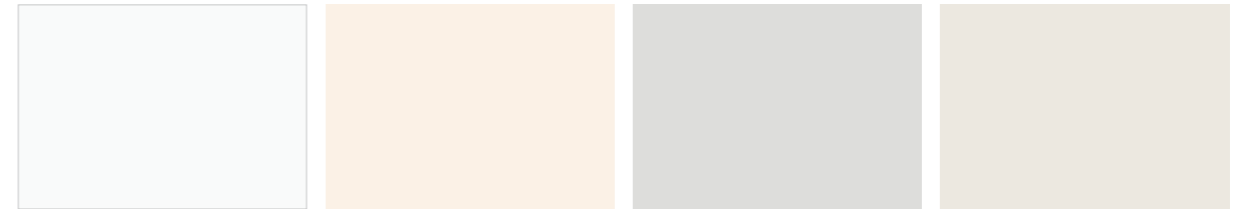

9016 - Traffic White

1015 - Light Ivory

7035 - Light Grey

9002 - Grey White



7040 - Window Grey

9006 - White Aluminium

7044 - Silk Grey

7030 - Stone Grey



5003 - Sapphire Blue

6005 - Moss Green

3003 - Rubinrot

6009 - Fir Green



7016 - Anthracite Grey

8016 - Mahogany Brown

8019 - Grey Brown



### EMBOSED

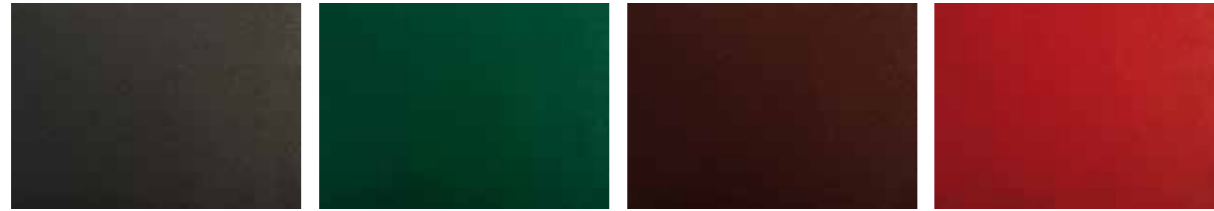

RAL 7016 Anthracite Grey    RAL 6005 Moss Green    RAL 8016 Mahogany Brown    RAL 3016 Coral Red



RAL 7040 Window Grey    RAL 9006 White Aluminium    RAL 9016 Traffic White

### WOOD-LIKE:



Light    Medium    Medium-dark    Dark

### WOOD TYPE:

Each wood type is proposed in a variety of finishes, using a water-based special paint, which ensures a satin finish and the best enhancement of the wood and an improved product durability. Two types of "treatments": impregnated and lacquered.

### METAL COATING:

The metal coating applied to the Multiecowood panels is available in 3 different versions:  
LAQUERED - available in 15 standard RAL colors or in RAL colors of your choice,  
EMBOSED - an embossed film is available in 7 standard colors,  
WOOD-LIKE - a wood-like film is available in the 4 standard wood colors.

# + OPTIONS

## HANDLES

Upon customer request, it is possible to enrich OVERLAP with a double handle (standard finish Platinbronze), which allows the manual operation of the door; the double handle becomes mandatory in the case of a garage with no other entrance or for

a manual door. To have always an optimal aesthetic integration, the handle is available in the following finishes: Platinbronze, Platinsilver, Aged Bronze or lacquered RAL.



Platinbronze



Platinsilver



Aged bronze



DUO Model - Lacquered okumè, RAL 9016 with Platinbronze double handle

# + TECHNOLOGY

PATENTED

OVERLAP TECHNOLOGY is a patented technology by Silvelox, which allows to the OVERLAP two sections to translate, rotate and finally overlap, requiring the minimum space in height and depth.

## OVERLAP TECHNOLOGY

innovative design

OVERLAP TECHNOLOGY groups the patented systems SILROLL, SILBLOCK and SILHOOK.



**PATENTED DOUBLE ROLLER 1/2**  
To obtain the minimum dimension with door open.



**PATENTED DOUBLE ROLLER 2/2**  
Allows inward panel displacement, for an improved safety.



**PATENTED LOCKING SPRING**  
It provides burglary and wind resistance.



**LOCKING SYSTEM WITH HOOKS**  
Allows you to increase security and is independent from the operator.

# + COMFORT

## AUTOMATION

The OVERLAP sectional door is equipped with the Silvelox operator, which works for all garage door sizes available in the catalog.

Completely integrated in the head-bar, it does not require any ceiling track and does not reduce the door clearance. Thanks to a self-diagnostic system, in case of malfunction, a flashing red LED, suggests to call for service repair. In case of power failure or of a malfunction, the operator can be disengaged and it is possible to operate the door manually.



**REMOTE CONTROLLING:** For automatic door operation, two or four channel remote controls are available. They ensure the state-of-art in security against cloning. The Silvelox remote controls are compatible with Homelink.

**NUMERIC KEYPAD:** made of stainless steel vandal-proof, is suitable for external application to the wall. The typed numerical code is processed by the electronic board and, if recognized as valid, generates the door opening.

# + SAFETY

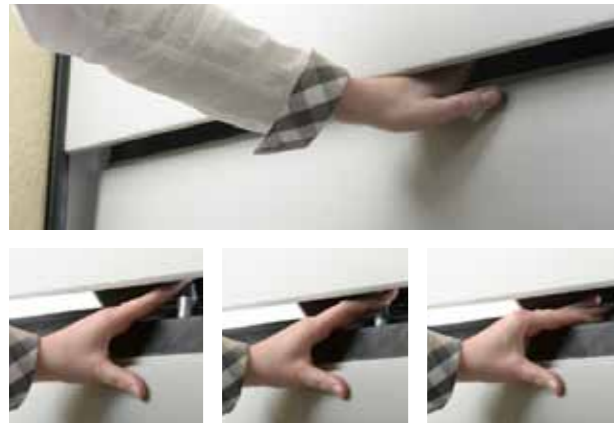

## ANTI-ENTRAPMENT

The anti-entrapment safety is ensured during closing by the operator current control, which senses the presence of any kind of obstacle and by the SILROLL, patented mechanical system, which avoids injuries in case of entrapment between the sections.

Mechanical anti-entrapment system SILROLL



Electronic anti-entrapment system of the operator



Watch the video

# + INSULATION

## THE COMPLETE DOOR FOR YOUR HOUSE INSULATION

In the last years, the housing industry cares more and more about energy saving and sustainability. Silvelox devoted always great importance to these themes, so as to obtain the Certification Partners KlimaHaus. The energy saving criteria require that the elements of the building envelope have a low thermal transmittance value, so as to reduce heat dispersion.

The OVERLAP Multiecowood panel is based on a production technology that enhances the wood for its proven durability, resistance and eco-compatibility, ensuring the door a thermal transmittance value of up to  $U = 1.00 \text{ W} / \text{m}^2 \text{ K}$  (value obtained for a door without windows and grills with behind wall installation).



**THERMAL TRANSMITTANCE**  
up to  $U = 1,00 \text{ W/m}^2\text{K}^*$

\* door without windows and grills with behind wall installation

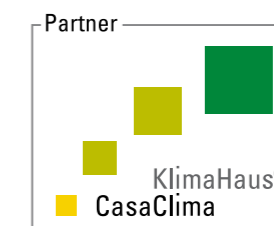

# + FLEXIBILITY

## IN INSTALLATION



### BETWEEN WALL INSTALLATION

This installation type is suited in case the wall opening does not allow fixing behind the opening. It is especially common in the case of a door replacement. Thanks to the self-supporting frame, OVERLAP can be fixed directly to the wall both laterally and superiorly, without the need for more supports. Cover boards are available on request, including insulating material, for complete coverage of the gap between frame and wall, without compromising the aesthetics and the seal of the door.



### BEHIND WALL INSTALLATION

This installation is performed when the wall opening presents enough side-room and head-room. In this case, the door frame is anchored behind the wall and it is possible to maximize door clearance. This solution should be preferred as it allows a better thermal insulation of the garage.



# + SOLUTIONS

The OVERLAP sectional door has an architecture that fits many type of buildings. It can be used in special situations which are characterized by the presence of slanted, vaulted, or beamed ceilings, and with oblique side walls or presenting a low radius of curvature.



## A SIGNIFICANT EXAMPLE

Thanks to the absence of ceiling tracks, OVERLAP allows the opening of a window placed on the side wall of the garage.

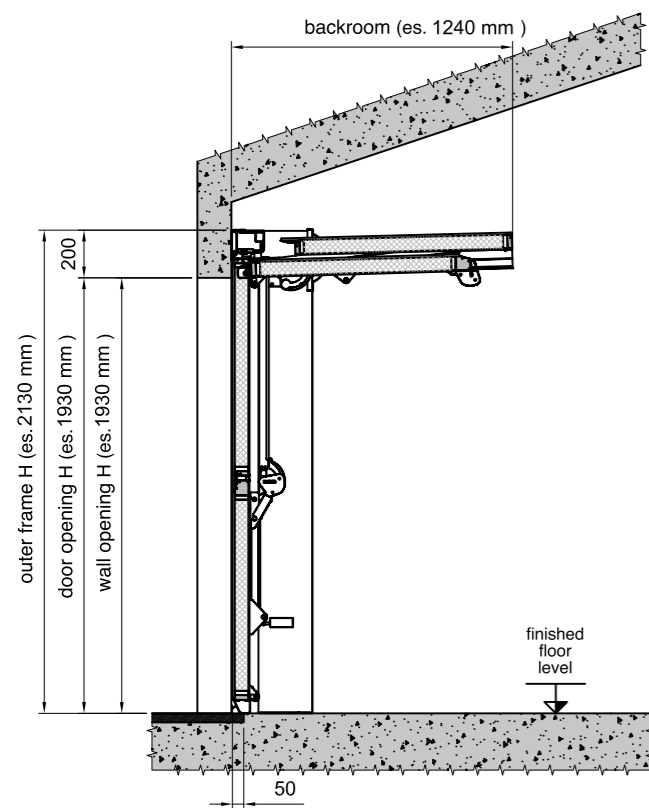

Garage with slanted ceiling

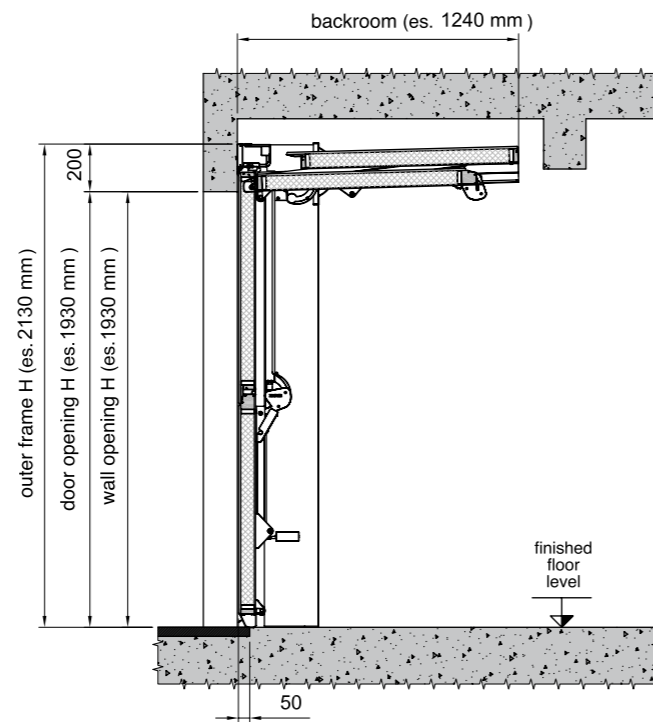

Garage with ceiling lowered by beams

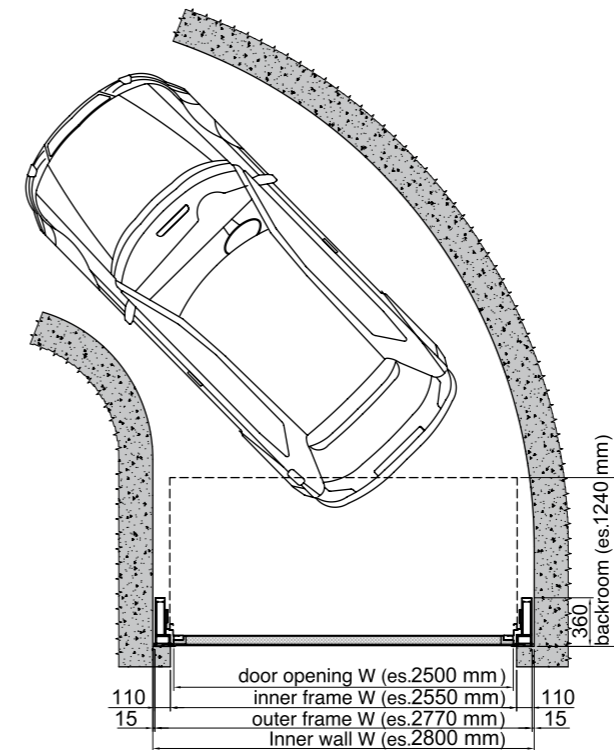

Garage with side walls presenting a low radius of curvature

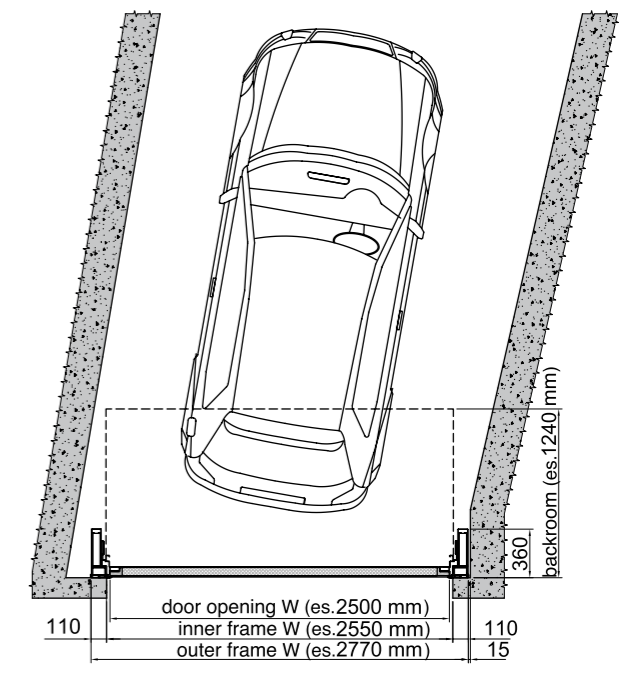

Garage with oblique side walls

# + SPACE

## DOOR CLEARANCE

You can park the car immediately behind the door both inside and outside; ideal for low-depth garages or openings flush with the street.

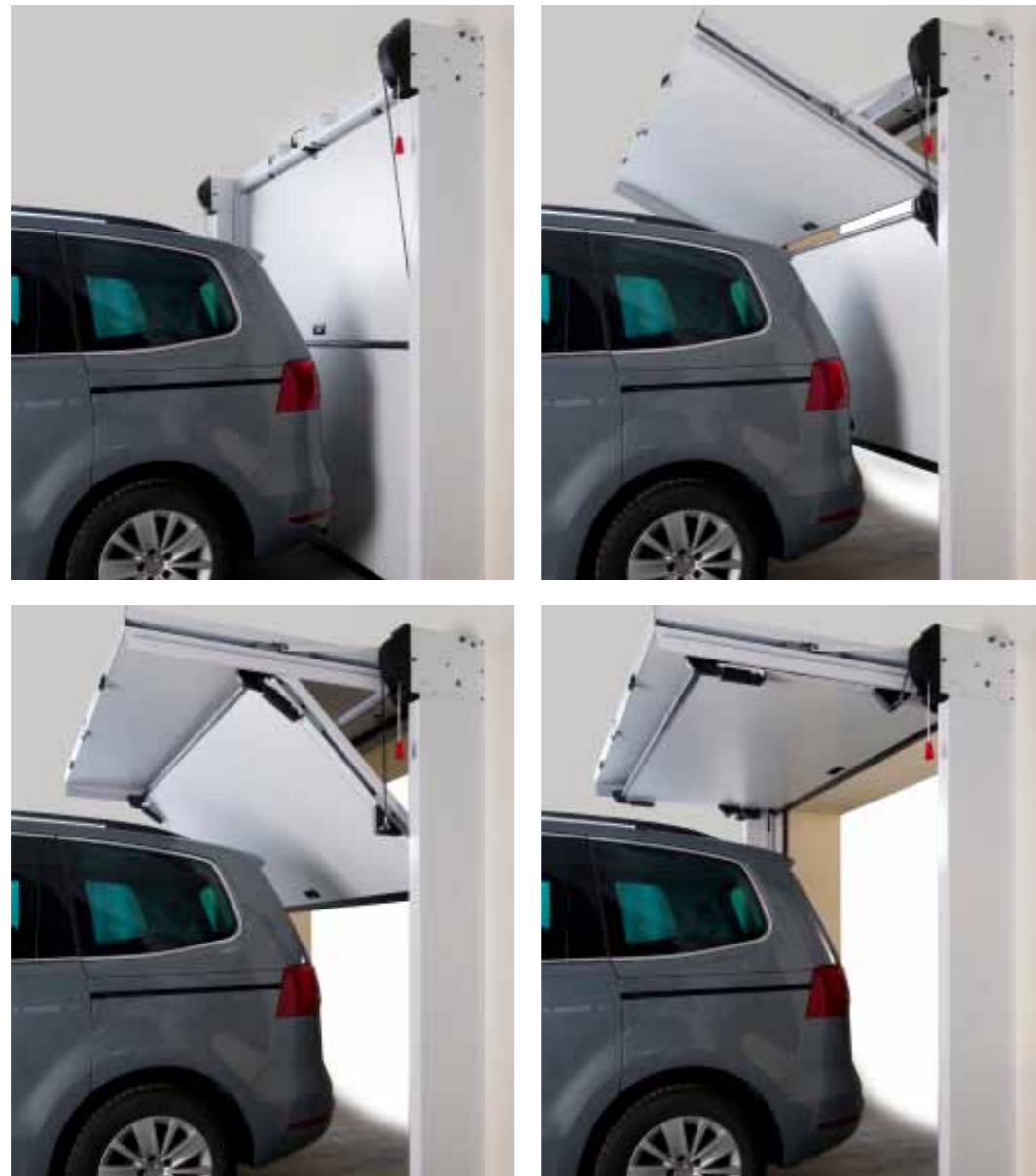

# + SIZE

## CUSTOM SIZE

OVERLAP is always custom made, both in width and height in steps of 50 mm. The aesthetics are adapted proportionally to size variation, keeping the overall effect appealing and harmonious.

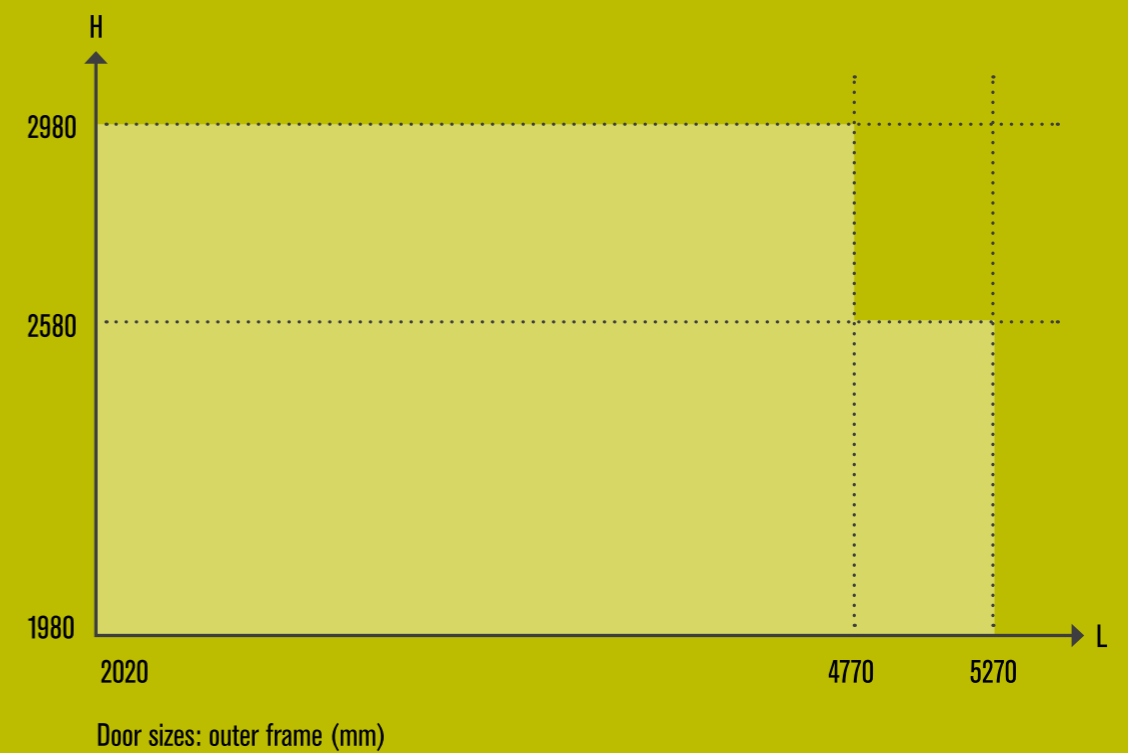

## DUO

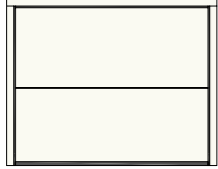
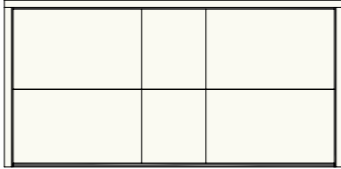

	W outer frame from 2020 mm to 3270 mm	W outer frame from 3320 mm to 5270 mm*
H outer frame from 2630 mm to 2980 mm	N/A	N/A
H outer frame from 1980 mm to 2580 mm	 <p>WOOD METAL</p> <p>drawing referred to a W 3270 mm by H 2580 mm door</p>	 <p>WOOD METAL</p> <p>drawing referred to a W 5270 mm by H 2580 mm door</p>

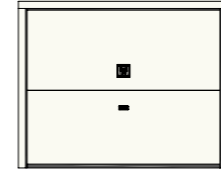
E.g. Door with double handle



drawing referred to a W 3270 mm by H 2580 mm door

## VIP

	W outer frame from 2020 mm to 3270 mm	W outer frame from 3320 mm to 5270 mm*
H outer frame from 2630 mm to 2980 mm	N/A	N/A
H outer frame from 1980 mm to 2580 mm	 <p>WOOD</p> <p>drawing referred to a W 3270 mm by H 2580 mm door</p>	 <p>WOOD</p> <p>drawing referred to a W 5270 mm by H 2580 mm door</p>

E.g. Door with double handle

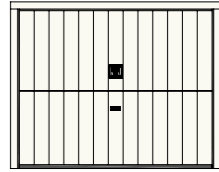

E.g. Door with double handle

## EMI

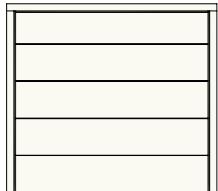
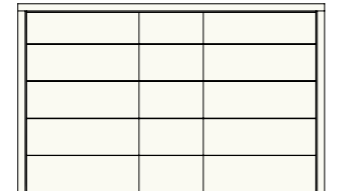
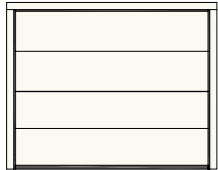
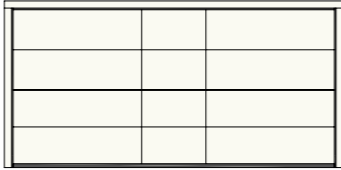
	W outer frame from 2020 mm to 3270 mm	W outer frame from 3320 mm to 5270 mm*
H outer frame from 2630 mm to 2980 mm	 <p>WOOD</p> <p>drawing referred to a W 3270 mm by H 2980 mm door</p>	 <p>WOOD</p> <p>drawing referred to a W 4770 mm by H 2980 mm door</p>
H outer frame from 1980 mm to 2580 mm	 <p>WOOD METAL</p> <p>drawing referred to a W 3270 mm by H 2580 mm door</p>	 <p>WOOD METAL</p> <p>drawing referred to a W 5270 mm by H 2580 mm door</p>

E.g. Door with double handle

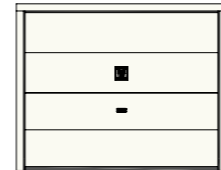

drawing referred to a W 3270 mm by H 2580 mm door

## ARA

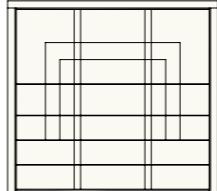
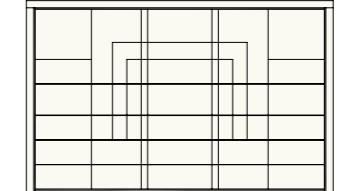
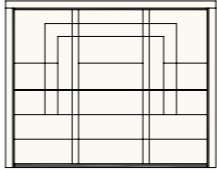
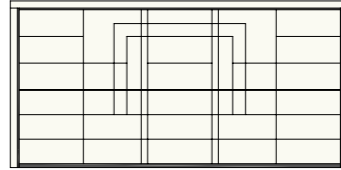
	W outer frame from 2020 mm to 3270 mm	W outer frame from 3320 mm to 5270 mm*
H outer frame from 2630 mm to 2980 mm	 <p>WOOD</p> <p>drawing referred to a W 3270 mm by H 2980 mm door</p>	 <p>WOOD</p> <p>drawing referred to a W 4770 mm by H 2980 mm door</p>
H outer frame from 1980 mm to 2580 mm	 <p>WOOD</p> <p>drawing referred to a W 3270 mm by H 2580 mm door</p>	 <p>WOOD</p> <p>drawing referred to a W 5270 mm by H 2580 mm door</p>

E.g. Door with double handle

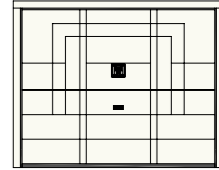

E.g. Door with double handle

## SIX

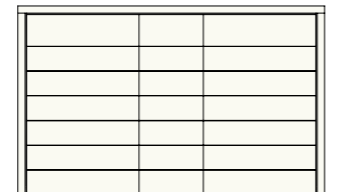
	W outer frame from 2020 mm to 3270 mm	W outer frame from 3320 mm to 5270 mm*
H outer frame from 2630 mm to 2980 mm	 <p>WOOD</p> <p>drawing referred to a W 3270 mm by H 2980 mm door</p>	 <p>WOOD</p> <p>drawing referred to a W 4770 mm by H 2980 mm door</p>
H outer frame from 1980 mm to 2580 mm	 <p>WOOD METAL</p> <p>drawing referred to a W 3270 mm by H 2580 mm door</p>	 <p>WOOD METAL</p> <p>drawing referred to a W 5270 mm by H 2580 mm door</p>

E.g. Door with double handle

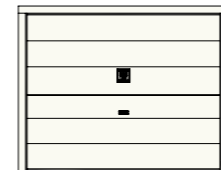

drawing referred to a W 3270 mm by H 2580 mm door

## TAU

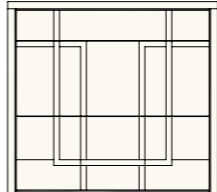
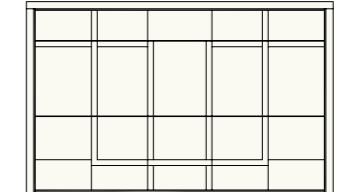
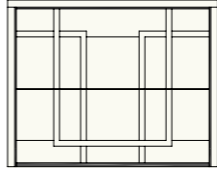
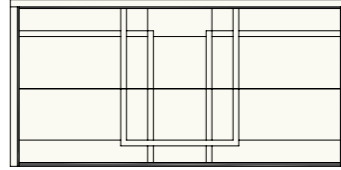

	W outer frame from 2020 mm to 3270 mm	W outer frame from 3320 mm to 5270 mm*
H outer frame from 2630 mm to 2980 mm	 <p>WOOD</p> <p>drawing referred to a W 3270 mm by H 2980 mm door</p>	 <p>WOOD</p> <p>drawing referred to a W 4770 mm by H 2980 mm door</p>
H outer frame from 1980 mm to 2580 mm	 <p>WOOD</p> <p>drawing referred to a W 3270 mm by H 2580 mm door</p>	 <p>WOOD</p> <p>drawing referred to a W 5270 mm by H 2580 mm door</p>

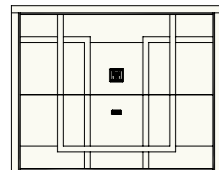
E.g. Door with double handle

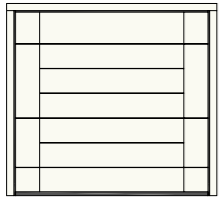
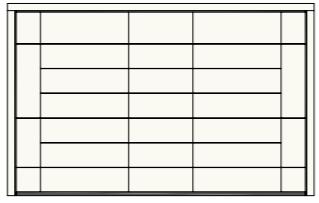
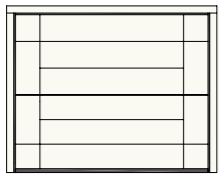

drawing referred to a W 3270 mm by H 2580 mm door

# GEO

	W outer frame from 2020 mm to 3270 mm	W outer frame from 3320 mm to 5270 mm*
H outer frame from 2630 mm to 2980 mm	 drawing referred to a W 3270 mm by H 2980 mm door	 drawing referred to a W 4770 mm by H 2980 mm door
H outer frame from 1980 mm to 2580 mm	 drawing referred to a W 3270 mm by H 2580 mm door	 drawing referred to a W 5270 mm by H 2580 mm door

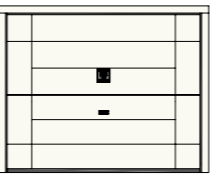
E.g. Door with double handle  
  
drawing referred to a W 3270 mm by H 2580 mm door

# SLOT

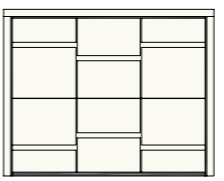
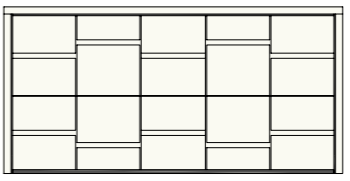
	W outer frame from 2020 mm to 3270 mm	W outer frame from 3320 mm to 5270 mm*
H outer frame from 2630 mm to 2980 mm	N/A	N/A
H outer frame from 1980 mm to 2580 mm	 drawing referred to a W 3270 mm by H 2580 mm door	 drawing referred to a W 5270 mm by H 2580 mm door

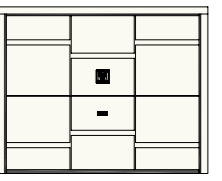
E.g. Door with double handle  
  
drawing referred to a W 3270 mm by H 2580 mm door

# SPI

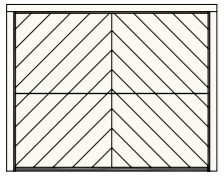
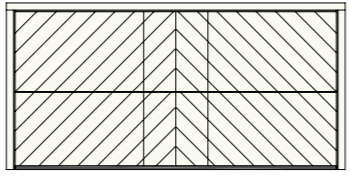
	W outer frame from 2020 mm to 3270 mm	W outer frame from 3320 mm to 5270 mm*
H outer frame from 2630 mm to 2980 mm	N/A	N/A
H outer frame from 1980 mm to 2580 mm	 drawing referred to a W 3270 mm by H 2580 mm door	 drawing referred to a W 5270 mm by H 2580 mm door

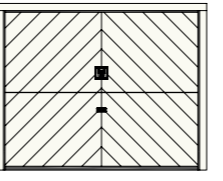
E.g. Door with double handle  
  
drawing referred to a W 3270 mm by H 2580 mm door

# TEX

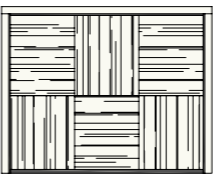
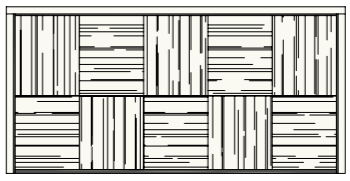
	W outer frame from 2020 mm to 3270 mm	W outer frame from 3320 mm to 5270 mm*
H outer frame from 2630 mm to 2980 mm	N/A	N/A
H outer frame from 1980 mm to 2580 mm	 drawing referred to a W 3270 mm by H 2580 mm door	 drawing referred to a W 5270 mm by H 2580 mm door

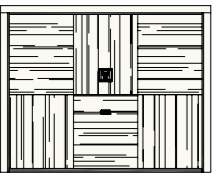

E.g. Door with double handle  
  
drawing referred to a W 3270 mm by H 2580 mm door

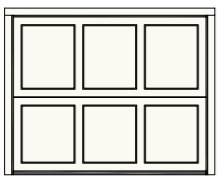
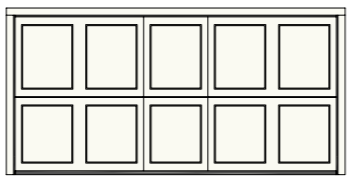
# BOX

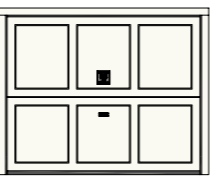
	W outer frame from 2020 mm to 3270 mm	W outer frame from 3320 mm to 5270 mm*
H outer frame from 2630 mm to 2980 mm	N/A	N/A
H outer frame from 1980 mm to 2580 mm	 drawing referred to a W 3270 mm by H 2580 mm door	 drawing referred to a W 5270 mm by H 2580 mm door

E.g. Door with double handle  
  
drawing referred to a W 3270 mm by H 2580 mm door

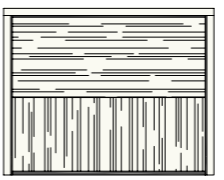
# TWO

	W outer frame from 2020 mm to 3270 mm	W outer frame from 3320 mm to 5270 mm*
H outer frame from 2630 mm to 2980 mm	N/A	N/A
H outer frame from 1980 mm to 2580 mm	 drawing referred to a W 3270 mm by H 2580 mm door	 drawing referred to a W 5270 mm by H 2580 mm door

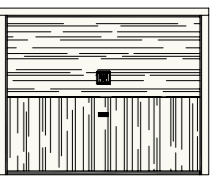
E.g. Door with double handle  
  
drawing referred to a W 3270 mm by H 2580 mm door

# TECH SPECS

Installation types:

## BETWEEN WALL INSTALLATION

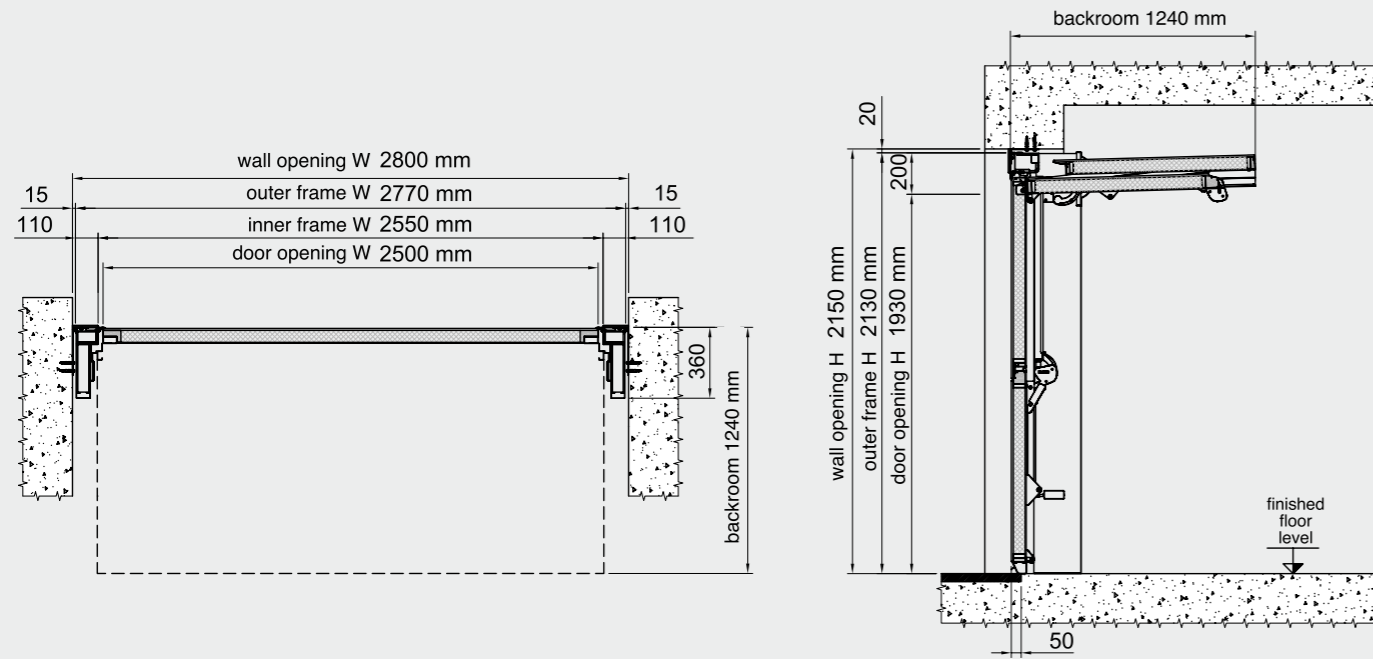

Installation types:

## PARTIALLY BETWEEN WALL INSTALLATION

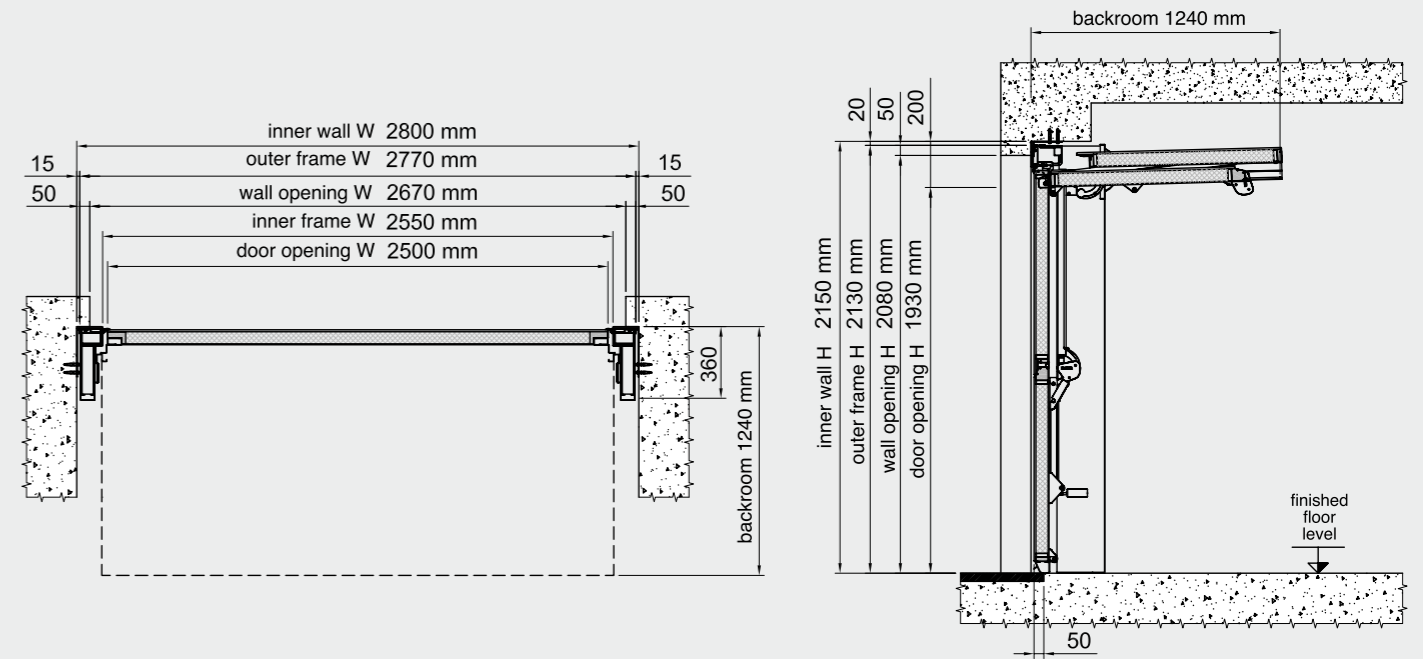

## FIXING DETAIL OF BETWEEN WALL INSTALLATION

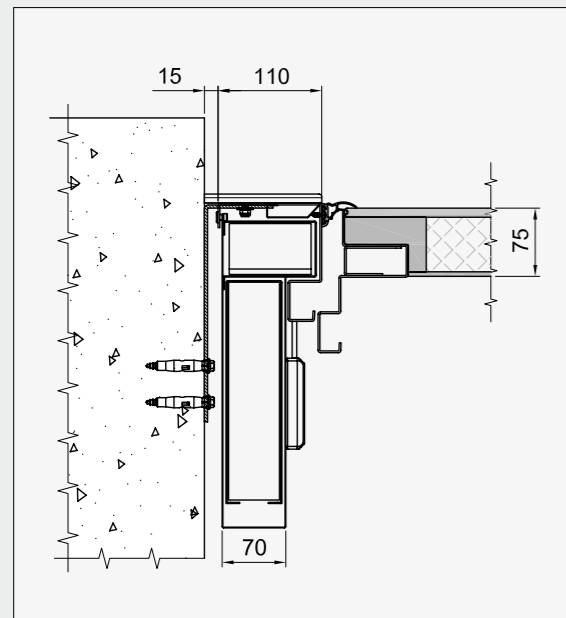

Horizontal section

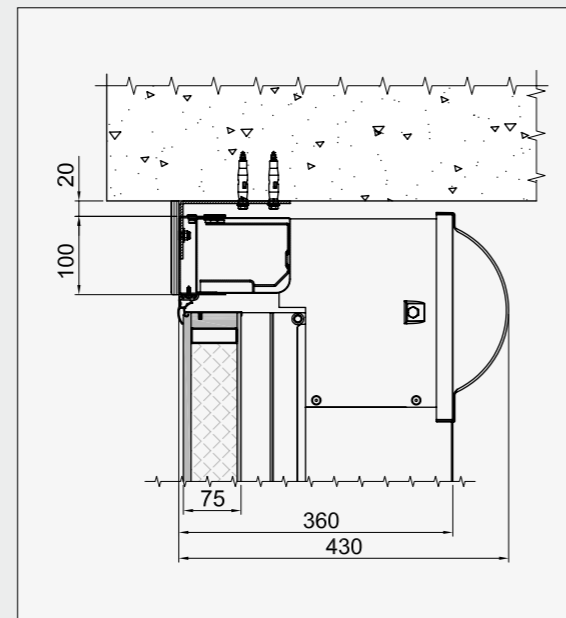

Vertical section

## FIXING DETAIL OF PARTIALLY BETWEEN WALL INSTALLATION

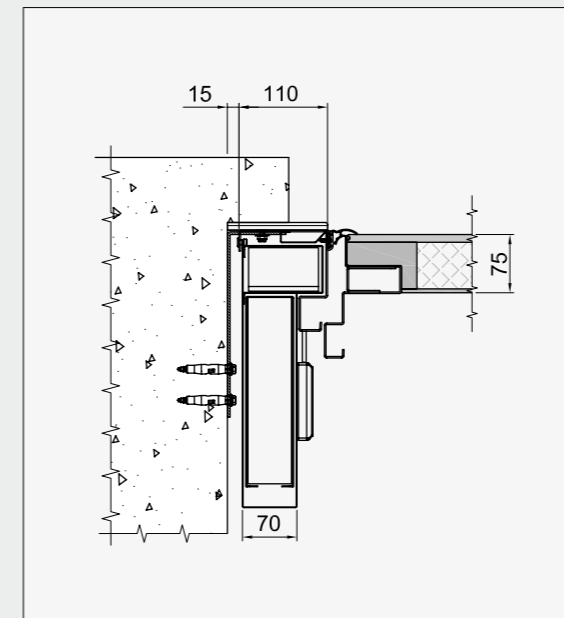

Horizontal section

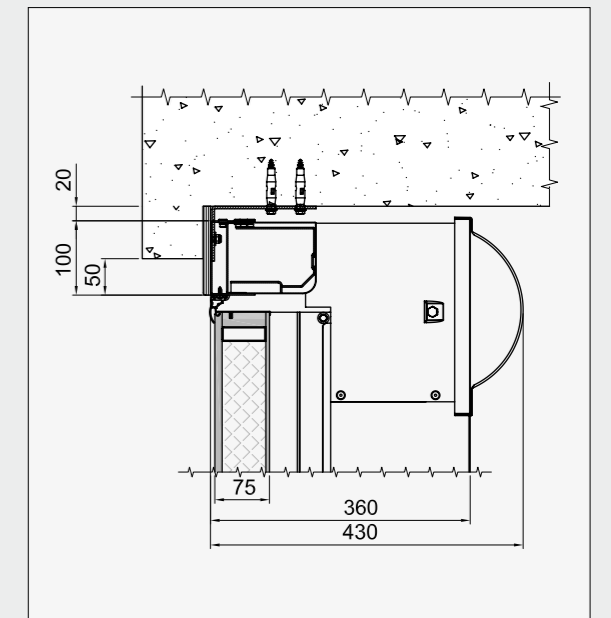

Vertical section

Installation types:

## BEHIND WALL INSTALLATION

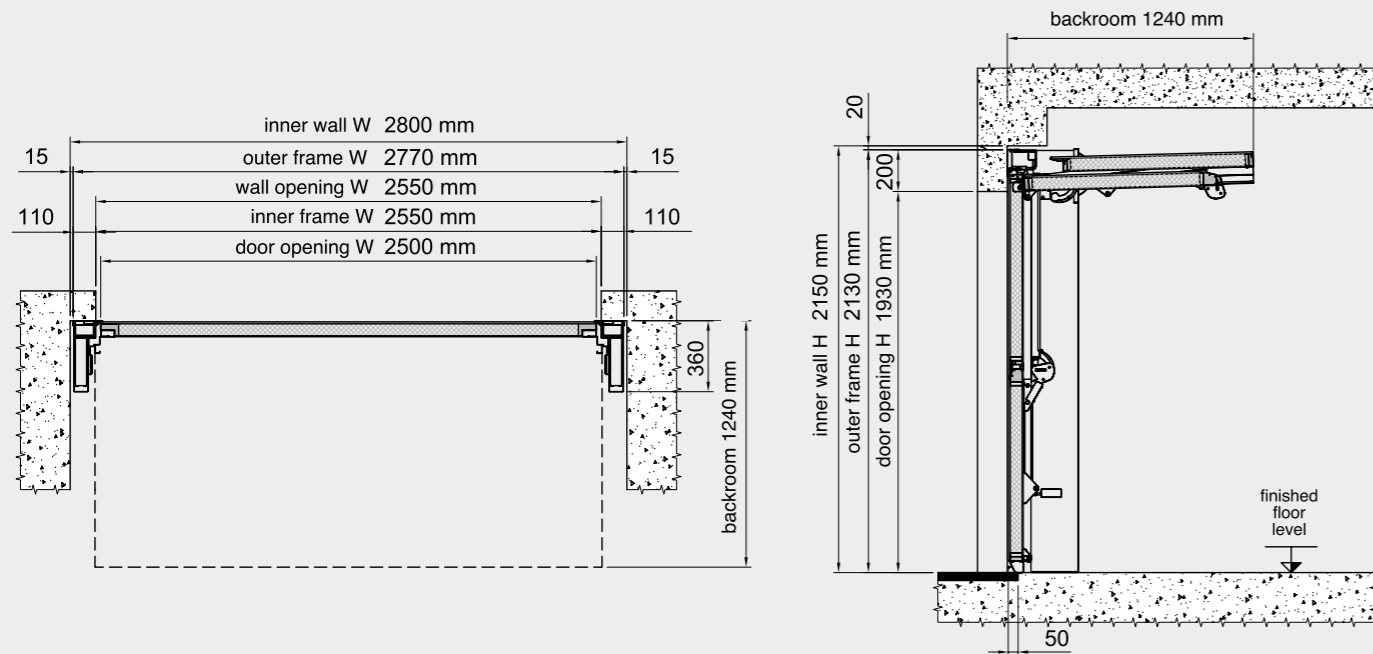

## FIXING DETAIL OF BEHIND WALL INSTALLATION

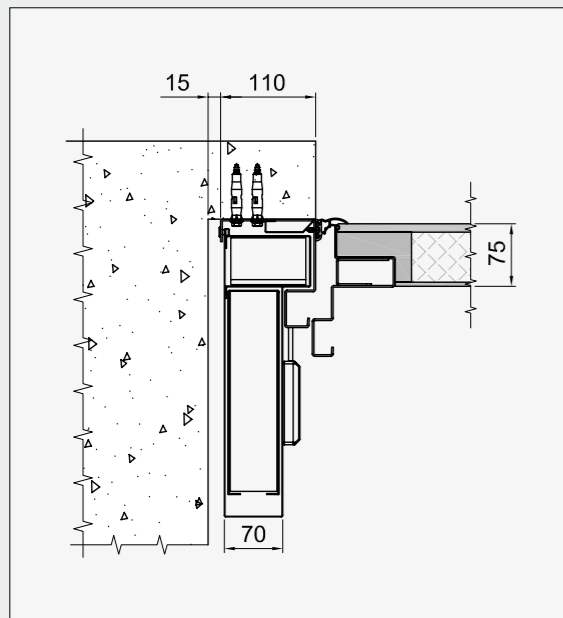

Horizontal section

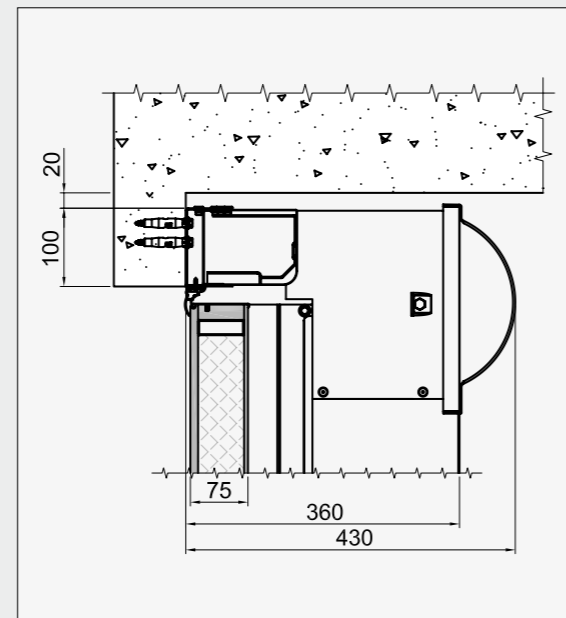

Vertical section

## TECH SPECS

- Sectional door made by two overlapping sections
- Sections made by structural sandwich panels in Multi-ecowood 75 mm thick.
- Frame made by 2 mm thick metal sheet, RAL 9016 white traffic varnished.
- Silvelox door operator integrated in the head-bar (for garages with no other accesses, a double handle has to be added, available as accessory). Additional receivers and remote controllers available upon request.
- Balancing through double counterweight system.
- Bottom and perimeter sealing in EPDM rubber anti-entrapment, water and wind proof.
- Outer side varnished with eco-friendly water based products or metal coated.
- Inner side RAL 9016 white traffic lacquered.
- Thermal transmittance  $U = 1 \text{ W/m}^2\text{K}$  (value obtained for a door without windows and grills with behind wall installation)
- Excellent performance in terms of acoustic insulation and water/wind proofing.

## THRESHOLD DETAIL

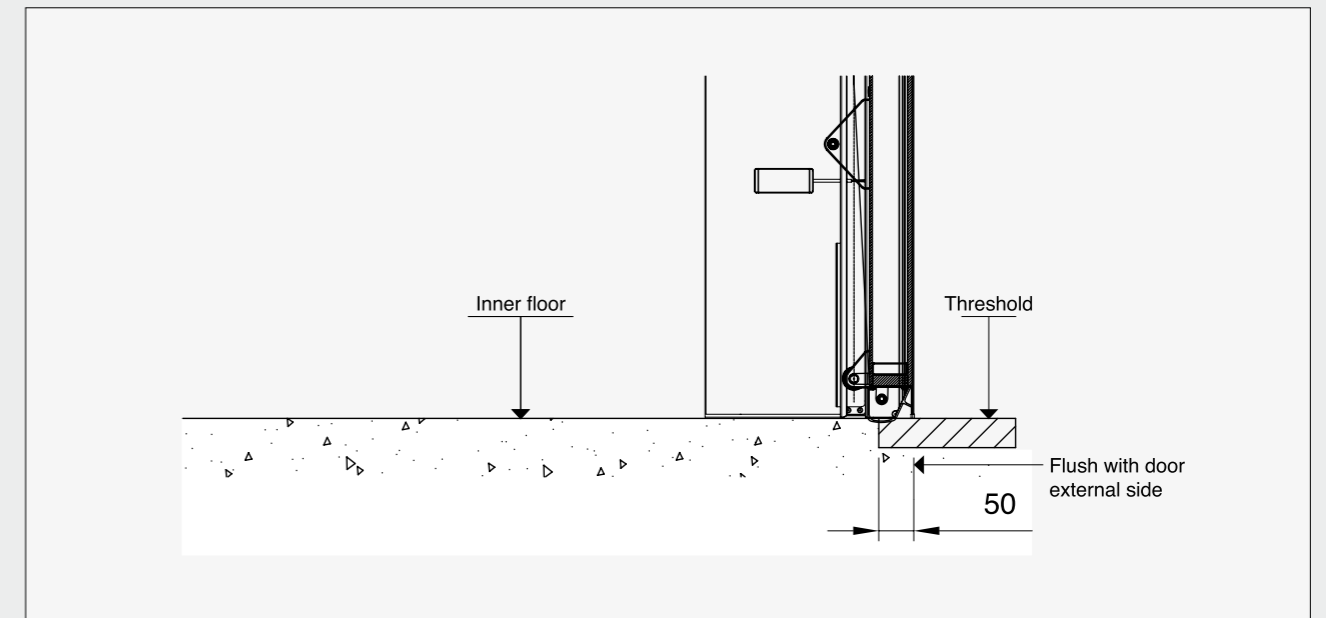

## DOOR CLEARANCE DIMENSIONS

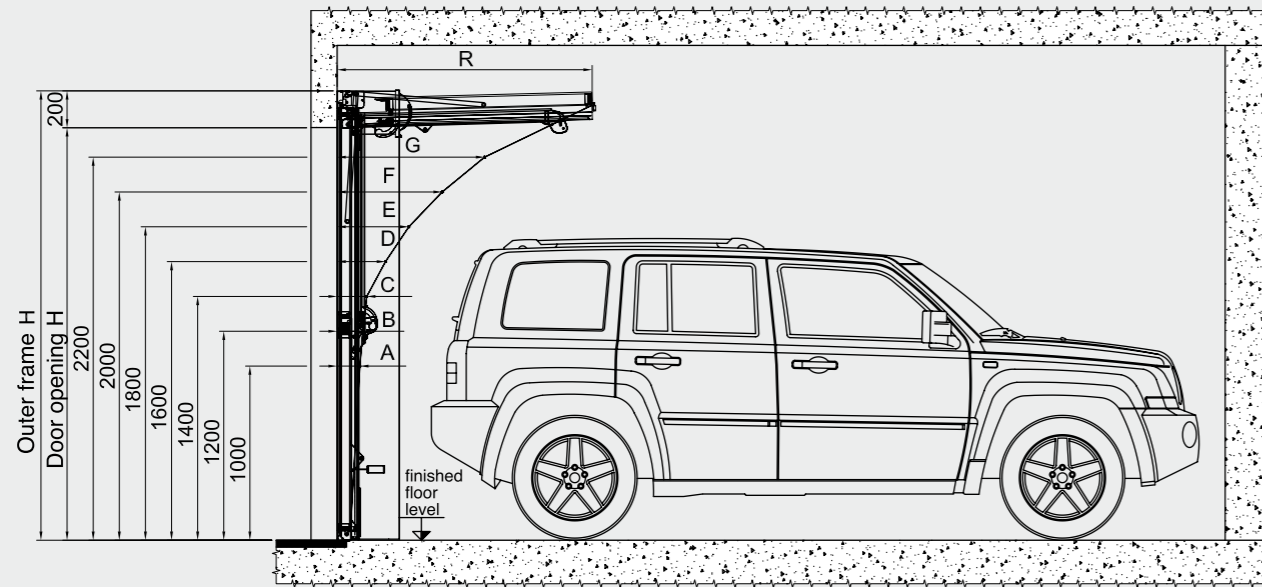

Outer frame H	Door opening H	A	B	C	D	E	F	G	R
		H 1000	H 1200	H 1400	H 1600	H 1800	H 2000	H 2200	
1980	1780	159	244	394	602	924	/	/	1165
2030	1830	156	227	369	564	858	/	/	1190
2080	1880	152	211	344	525	791	/	/	1215
2130	1930	149	194	319	487	725	/	/	1240
2180	1980	147	186	300	460	685	/	/	1265
2230	2030	145	177	281	432	646	/	/	1290
2280	2080	142	169	261	405	606	/	/	1315
2330	2130	140	160	242	377	566	776	/	1340
2380	2180	138	158	227	357	536	741	/	1365
2430	2230	137	155	213	338	505	706	/	1390
2480	2280	135	153	198	318	475	670	/	1415
2530	2330	133	150	183	298	444	635	896	1440
2580	2380	131	148	170	278	412	603	847	1464
2630	2430	130	147	168	272	405	590	820	1515
2680	2480	129	146	166	267	399	577	793	1565
2730	2530	128	144	165	262	394	564	766	1614
2780	2580	127	143	163	257	388	551	739	1664
2830	2630	127	142	162	253	383	539	726	1714
2880	2680	126	141	160	249	377	527	714	1764
2930	2730	126	140	159	245	372	514	701	1814
2980	2780	125	139	157	241	366	502	688	1864

Measures in mm

# + WARRANTY

Up to **10 years**

In addition to the 2-year legal warranty, Silvelox supports its customers over time offering them an additional coverage period for a total of:

- 10 years on metal parts
- 5 years on duration of the waterproof film applied to wood components and on the metal coating applied to the door panels (excluded dark colours)

In accordance with the recommendations in the Silvelox sale conditions and in the installation and owner's manual.



# SILVELOX

devoted to design

SILVELOX S.p.A.

I-38050 - Castelnuovo (Trento)

Viale Venezia, 37

Tel. +39 0461 755755

Fax +39 0461 752466

[silvelox@silvelox.it](mailto:silvelox@silvelox.it)

[www.silvelox.it](http://www.silvelox.it)